

IATA CABIN OPS SAFETY CONFERENCE

Lisbon, Portugal
14-16 June 2022

PROGRAM



IATA CABIN OPS SAFETY CONFERENCE

Day 1 - Tuesday, 14th June

- 09h00 – 09h10** **Welcome Address**
Orientation and welcome to the COSC event, highlighting the key networking features and learning opportunities
[- Jonathan Jasper, Senior Manager Cabin Safety, IATA](#)
- 09h10 – 09h20** **Welcome from our Host and Principal Sponsor**
Welcome to Lisbon from our principal sponsor TAP Portugal
- 09h20 – 10h15** **IATA Cabin Safety and other related activities**
An insight into the activities of IATA Cabin Safety and Cabin Operations over the last two years, and issues being addressed as we move forward from the pandemic.
[- Jonathan Jasper, Senior Manager Cabin Safety, IATA](#)
- 10h15 – 10h45** **NETWORKING BREAK**
- 10h45 – 11h15** **ICAO Cabin Safety**
An update on the activities of the ICAO Cabin Safety Group including recent publications and ongoing workplan.
- Martin Maurino, Technical Officer, Global Aviation Safety, ICAO - TBC
- 11h15 – 11h45** **IATA's Advocacy for Accessibility**
An insight into the challenges of improving and maintaining accessibility for all, within the heavily regulated arena of cabin operations.
[- Linda Ristagno, Assistant Director External Affairs, IATA](#)
- 11h45 – 12h30** **Unruly Passenger campaign - EASA**
In response to the noted increase of unruly passenger incidents throughout the pandemic, EASA, with the help of cabin crew, airlines and human factors specialists, embarked on a campaign to help airlines to educate passengers before they travel.
[- John Franklin MBE, Head of Safety Promotion, EASA](#)
[- Kris Major, European Transport Workers Federation, UNITE the union.](#)
- Meghan Doyle, Inflight Safety, Security, Regulatory and Compliance Mgr, Ryanair
- 12h30 – 14h00** **NETWORKING LUNCH**
Location



IATA CABIN OPS SAFETY CONFERENCE

Day 1 - Tuesday, 14th June

- 14h00 – 15h00** **Pátio Lisboa - Table discussions - Session 1**
3 x 20-minute sessions
Quickfire discussions on Cabin Safety's hottest topics
- 15h00 – 15h30** **NETWORKING BREAK**
- 15h30 – 17h00** **Pátio Lisboa - Table discussions - Session 2**
3 x 20-minute sessions
Quickfire discussions on Cabin Safety's hottest topics
Followed by a debrief
- 17h00 – 18h30** **NETWORKING WELCOME RECEPTION**



IATA CABIN OPS SAFETY CONFERENCE

Day 2 - Wednesday, 15th June

Delegates can select 2 out of 3 workshops:

09:00-12:30	Turbulence	Cabin crew wellbeing	Safety Management
12:30-14:00	Networking Lunch	Networking Lunch	Networking Lunch
14:00-17:00	Turbulence	Cabin crew wellbeing	Safety Management

Turbulence

Turbulence remains one of the biggest causes of injury in the cabin and is regularly featured on the radar of many Safety Professionals. This workshop looks at communication methods, procedures, and initiatives used by airlines to ensure that cabin crew are informed, prepared and able to play their part in preventing injury.

Cabin Crew Well Being

The challenges of operations while we transition from pandemic to endemic continue to affect cabin crew around the world to varying degrees. This workshop looks at what can be done to support cabin crew as we recover and grow, and what issues might need careful handling in order to ensure that safety is not affected.

Safety Management

The International Civil Aviation Organization has recently published DOC 10158, Manual on Safety Management in Cabin Operations, which is aimed at giving regulators the information they need to oversee airlines and their Safety Management processes. Join this workshop to talk with other airlines and see how they are implementing Safety Management effectively, aligning with best practices



IATA CABIN OPS SAFETY CONFERENCE

Day 3 - Thursday, 16th June

09h00 – 09h30

Human Trafficking

The fight against human trafficking continues. What new issues have arisen as a result of the pandemic and how do we need to adapt for the future as we emerge from the crisis.

- [Emily Manduku, Flight Operations Inspector, Kenya Civil Aviation Authority](#)

09h30 – 10h00

Crew engagement

Cabin crew wellbeing and mental health is one of the new issues identified during a turbulent two years in aviation. How can we demonstrate that we are listening to and responding to concerns raised by our cabin crew?

- [Andrew Judge, Head of cabin services, X-Fly](#)

10h00 – 10h30

Cabin Crew Quick Reference Handbook (QRH)

Cabin crew practical manuals are a condensed version of the operations manual, providing checklists and information to help cabin crew in their daily safety related tasks. As there is no standard recommendation on a required format, this presentation looks at some of the methods used to comply with this IATA Operational Safety Audit standard.

- Julia Arnds, Flight Safety Cabin Specialist, Lufthansa

10h30 – 11h00

NETWORKING BREAK

11h00 – 11h30

Cabin Design

Innovative cabin design is welcomed as it allows us to transform the passenger and crew experience. However, innovation must also be safe and accessible and comply with certification standards. What needs to be addressed in order to evolve cabin innovation?

- [Edwin Fernandez, Manager Inflight Service, Cabin Safety, Analysis & Technology, Delta Air Lines.](#)

11h30 – 12h00

Disabled Lavatory design

Airlines are taking the issue of accessibility seriously but there are a variety of differing and sometimes conflicting regulations to navigate. This presentation looks into some of these challenges and seeks to bring them up to date to help airlines and cabin crew to improve accessibility onboard.

- [Antti Suopajarvi, Accessible Air Travel Specialist](#)



IATA CABIN OPS SAFETY CONFERENCE

Day 3 - Thursday, 16th June

12h00 – 12h30

Line Operations Safety Audit introduction

It is rare to find an airline which has adapted LOSA program from flight operations into cabin operations. This presentation from GOL Linhas Aereas on their introduction of LOSA CAB program will give practical examples for implementation,

- Renata Borges, Cabin Crew Strategic Management Cabin Standards Analyst, GOL
- Danilo Mirabetti, Cabin Safety Analyst – GOL

12h30 – 14h00

NETWORKING LUNCH

14h00 – 14h30

Supporting airlines and cabin crew through the crisis

MedAire partners with the commercial aviation industry to keep passengers and crew safe while travelling in the air or on duty. Hear from Medaire on their activities during the pandemic and how they aim to continue supporting crew health and wellbeing as we recover.

[Richard Gomez, Vice President Product Development and Management, Medaire](#)

14h30 – 15h15

Airlines 4 America (A4A) Panel discussion

Cabin Ops Collaborative Response to Covid-19 and how we are better prepared to handle the next Global Crisis or Pandemic and how to navigate the aviation industry post pandemic.

[- Led by Cari Smith Allen, Manager Cabin Safety Alaska Airlines & A4A Chair](#)

15h15 – 15h45

NETWORKING BREAK

15h45 – 16h30

Cabin Operations Safety Task Force (COSTF) Panel discussion

This team of experts from around the world meet regularly to identify solutions and best practices to help the industry maintain safe operations and are the eyes and ears of IATA in the operational environment. This panel discussion is aimed to provide delegates the opportunity to engage and ask questions on what we can do to safely restore the business of freedom.

[- Led by Anabel Brough, Safety Manager Cabin, Emirates Airline & COSTF Chair](#)
[- Carlos Dias, Cabin Safety Officer TAP Portugal & COSTF Vice Chair](#)

16h30 – 16h45

Close of COSC 2022

Summary and closing remarks from the COSC 2022

[- Jonathan Jasper, Senior Manager Cabin Safety, IATA](#)



IATA

CABIN OPS

SAFETY

CONFERENCE



A STAR ALLIANCE MEMBER 

Bem Vindo



Jonathan Jasper

Senior Manager Cabin
Safety

IATA



Cabin Ops Safety Conference

The **COSC** is the leading global event for safety professionals, covering every aspect of cabin operations and safety.

14-16 June 2022,
at the Epic Sana Lisboa,
Lisbon, Portugal.

For: Airlines, Safety Consultants, Cabin Crew, Solution Providers, Cabin Product And Service Designers, Cabin Safety Auditors, Safety Equipment Providers.

Features:

- Risk assessment
- Cabin crew mental health
- SMS
- Human trafficking
- Unruly passengers

IATA
CABIN OPS
SAFETY
CONFERENCE

370+
Attendees

100+
Airlines

25+ **160+**
Media & Companies
exhibitors

Pre-departure questionnaire - Who are you?

Have you been to the IATA COSC before?

Are you, or have you ever been, a cabin crew member?

Are you currently employed by an airline?

Are you currently employed by an aviation authority/regulator?

Are you as happy as I am to be here with a face-to-face event?

Who are we?

Nancy Rockbrune



Brent King



Linda Ristagno



Ligia Fonseca



Covid-19

- Respect others comfort level
- Wash hands frequently

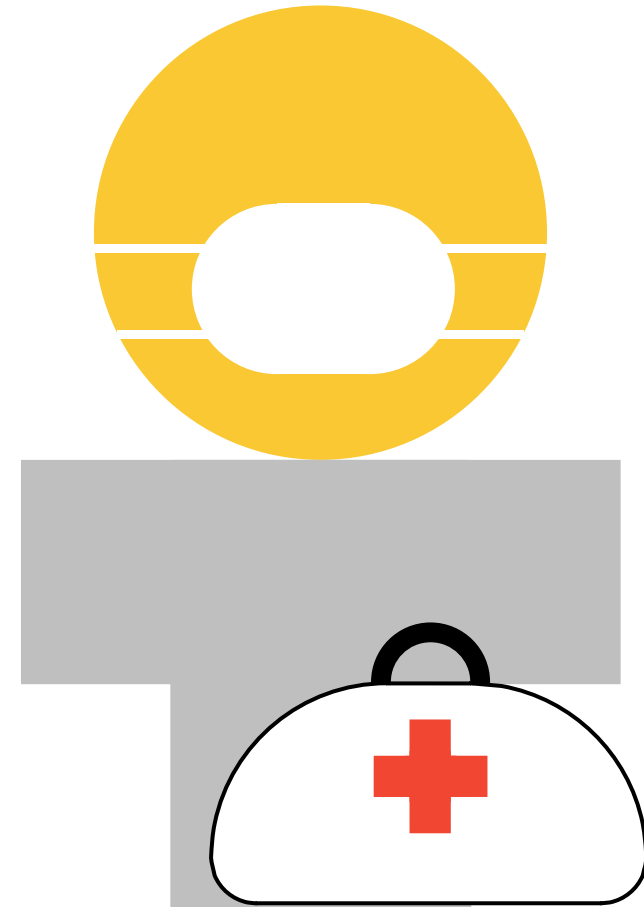

What's on the agenda?

Day 1

- Global updates
 - IATA
 - ICAO
 - EASA
- Cabin Safety Exchange
- **Welcome reception**

Day 2

- Workshops
 - Safety Management
 - Turbulence
 - Cabin Crew wellbeing and mental health
- **Evening Event**

Day 3

- Plenary
 - Presentations
 - Panel discussions
- Prizes

Competition law guidelines

Prohibited discussions (unless already made public)

- Individual airline **rates, charges, or surcharges**;
- Individual airline **costs**;
- An individual airline's **intentions regarding increasing, reducing, or reallocating aircraft capacity (including entering or exiting routes)**;
- An individual airline's intentions regarding **charging for certain products or services or changes to the existing charges for such products or services**;
- Information on individual airline customers; and
- Any other sensitive commercial or proprietary information that the company would not disclose in the absence of an express or implied agreement to exchange such information for the purpose of reducing or restricting competition in the airline industry.

Photograph competition

Theme

Prize

How to enter

**Connecting
Portugal to the
world**

Provided by TAP

Post it on
Instagram
(make sure your
account is
"public")

#IATACabinsafety
and **@iatacosc**

OR

E-mail to
cabin_safety@iata.org and we
will post it on
Instagram for
you.

Other competitions and prizes

TAP's Cabin Crew Challenge

TAP's "I can't hear you"



The event APP



Thank you for your support



Our host airline

TAP AIRPORTUGAL

A STAR ALLIANCE MEMBER



Jonathan Jasper

Senior Manager Cabin
Safety

IATA



Introduction



The past two years....



The past two years....

EasyJet, American Airlines to slash workforce amid pandemic

European budget carrier easyJet and American Airlines both plan to cut large parts of their workforces as the global aviation industry struggles to cope with a near total halt to travel amid the COVID-19 pandemic

By Danica Kirka Associated Press
May 28, 2020, 9:34 AM

Share

REUTERS | Reuters Videos

Airline Virgin Australia to slash workforce

August 5, 2020

Airline Virgin Australia says it plans to cut a third of its workforce, a last ditch effort to overhaul itself amid the global health crisis.

On Wednesday (August 5) the company said 3000 jobs would be axed, as the carrier offloads its wider-body planes like the Boeing 777.

Air Canada to Slash Workforce By Between 50% and 60% as Coronavirus Decimates Airline Industry

PADDLE
KANO
16TH MAY 2020

HONG KONG

Cathay Pacific to slash workforce by nearly a quarter and close Cathay Dragon

by AFP
07:23, 21 OCTOBER 2020



Lufthansa-owned Brussels Airlines to slash workforce

MAY 12, 2020 11:10 PM PHT
AGENCE FRANCE-PRESSE

Hiring & Firing | layoff | News

Air France to slash 40% of workforce by 2022

Read 2607 Times

By HRK News Bureau - July 2, 2020

0



Risks of sudden workforce reductions

What are the hazards?

Disgruntled ex employees

Low morale among remaining workforce

Reduced public confidence

Poor public image

What are the consequences?

Fear of reporting safety incidents

Culture shift from collaboration to "self preservation"

Loss of experience and knowledge



And where are we now?



Tensions flared as flight cancellations continue (Image: LTI Media)

NEWS POLITICS FOOTBALL CELEBS TV MONEY TRAVEL

Stranded passengers yell at airport staff as Wizz Air flight cancelled in travel chaos

Fears grow for summer holidays after flight cancellations

By Michael Race & Faara Masud
Business reporters, BBC News

50 minutes ago



Cancelled flights and delays at airports are fuelling anxiety among UK holidaymakers ahead of the key summer season, travel agents have warned.

CNN travel DESTINATIONS FOOD & DRINK NEWS

Mayhem predicted for travel this summer

Julie Barkley, CNN - Updated 4th June 2022



EveningStandard Evening Standard

Travel delays latest: British Airways and EasyJet cancel more flights as aviation bosses slammed over holiday chaos



Elly Blake and Esra Arah

Wed, June 1, 2022, 4:31 p.m. - 25 min read



Travel delays latest: British Airways and EasyJet cancel more flights as aviation bosses slammed over holiday chaos

Airline group urges feds to take action to reduce delays at Canadian airports

Al Sciola | May 25 2022, 10:16 am



The Atlanta Journal-Constitution

Local News Georgia Primary Dining Guide: Pizza Opinion EPaper Sports Newsletters

Airline delays, mishandled baggage worsened amid rebound in travel



Credit: anin.sankapaj.com

ATLANTA AIRPORT BLDG
By Kelly Yamanouchi, The Atlanta Journal-Constitution

TRENDING

- Canadian Bank Stocks Smash Earnings: Buy Them All With This ETF
- Strong Buys Hit a Home Run With 2



Skills gap



Challenges for cabin safety

Cabin crew experience

Recruitment volumes

Training and induction volumes

Cost of living increases vs salary

Attracting cabin crew to the role

Is there any increase in safety errors?



Aviation Workers Skills Gap Survey

IATA commissioned survey

Aimed at HR Managers, cabin crew Management teams etc.

Closing date extended for this Conference!



Skilled Staff Portal

The screenshot shows a SharePoint page for the 'Skilled Staff Portal'. At the top, there is a blue header with the IATA logo and 'SharePoint' text on the left, and a search bar with the text 'Search this site' on the right. Below the header is a navigation bar with a home icon, a globe icon, and a blue button labeled 'SS' followed by the text 'Skilled Staff Portal'. To the left of the main content area is a vertical navigation menu with icons and labels for: Home, Pilots, Mechanics and Engineers, Traffic Controllers, Ground Handlers, Cabin Crew, Recycle bin, and Edit. The main content area features a large banner image of a child holding a paper airplane in front of a window, with the text 'Skilled Staff Portal' overlaid. Below the banner is a grid of six tiles: a large 'Pilots' tile with a cockpit view and a 'Learn more' link; a 'Mechanics and Engineers' tile showing a person working on an aircraft; a 'Traffic Controllers' tile with a green traffic light; a 'Ground Handlers' tile showing two people in high-visibility vests; and a 'Cabin Crew' tile showing airplane seats. To the right of the grid are two blue buttons: 'Aeronautical Skills Working Group (ASWG)' and 'Pilot Training Task Force'.



Unruly Passengers

An ongoing concern for
many



Let's go...!

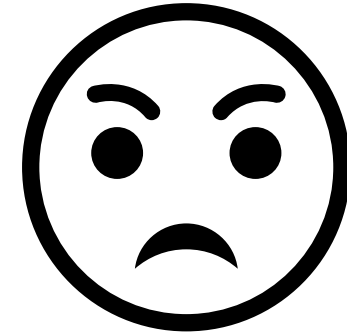
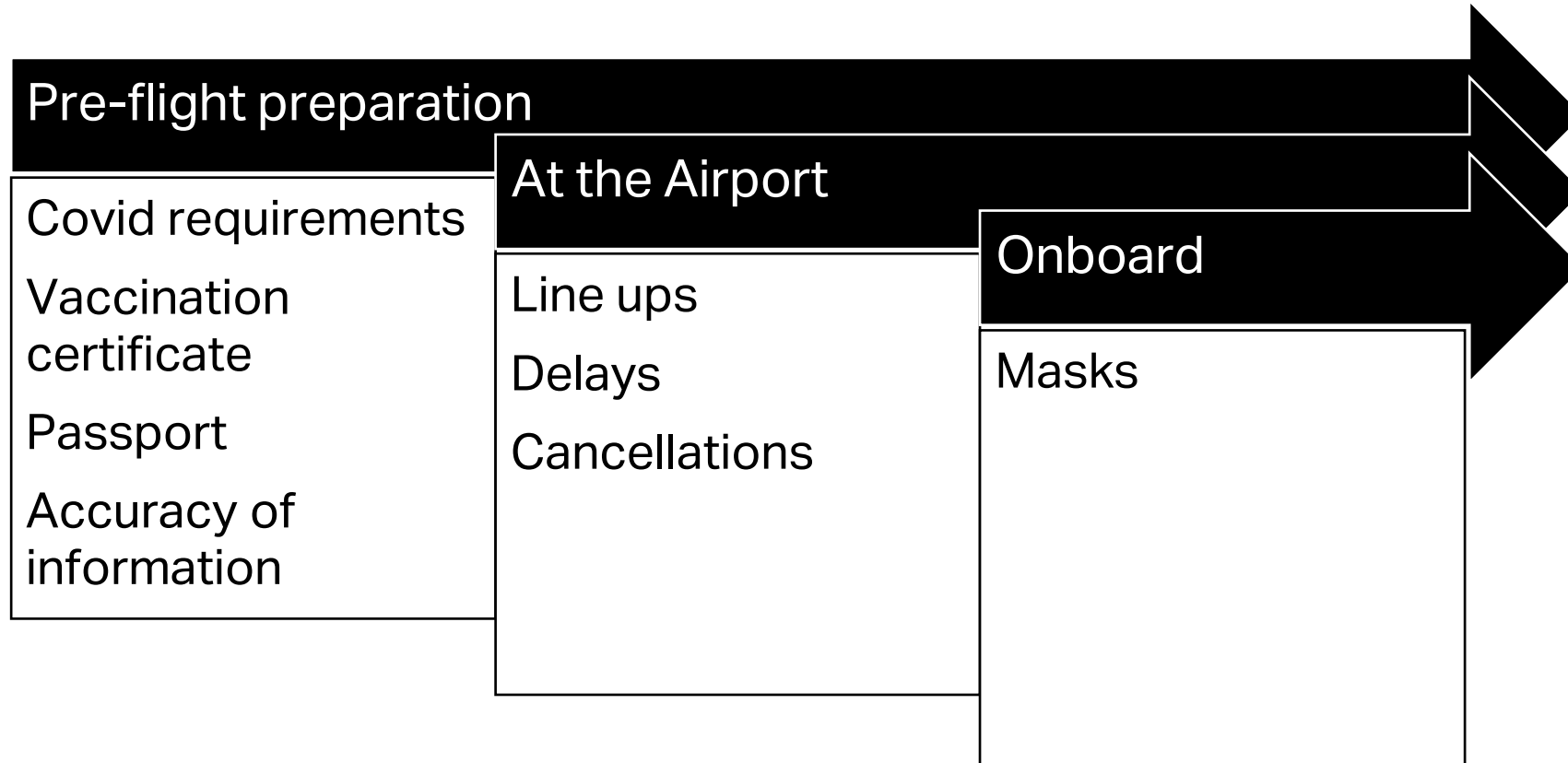

Reporting rates

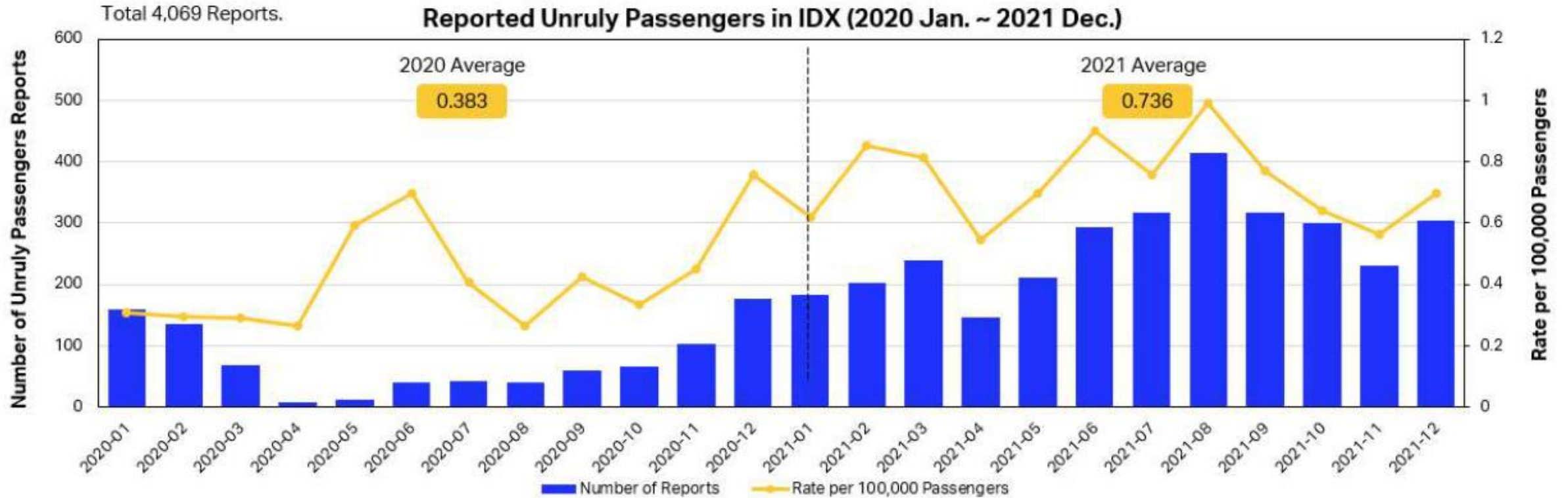

Reporting rates

**Unruly Passenger Category
2020 vs 2021
Normalized by the 100,000 Passengers**

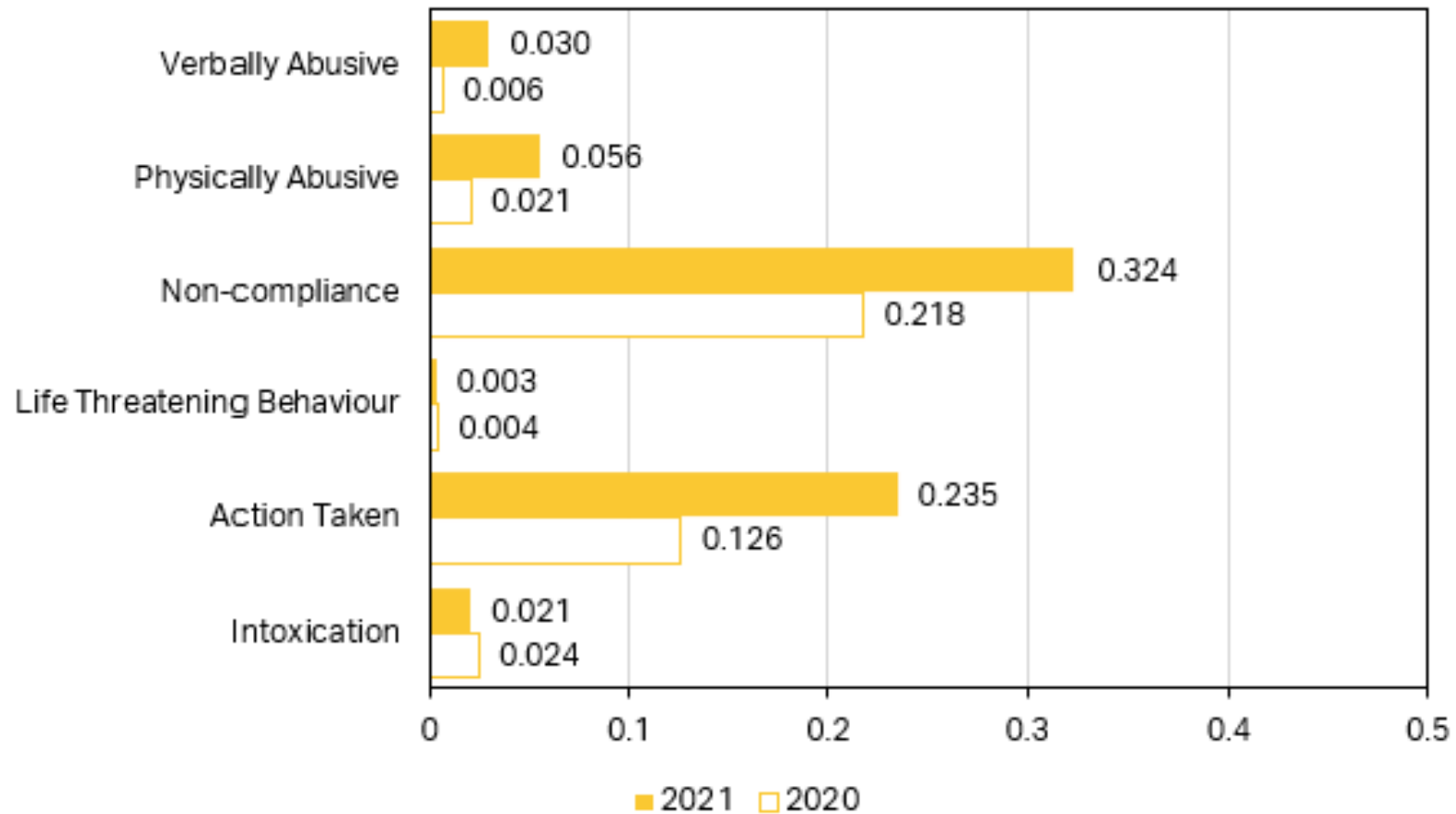

Observations from narratives

Covid-19 compliance

- Masks
- Seating
- Food and drink

Increasing number of physical events

Some evidence of “mental distress” events not attributed to intoxication

Actions

- Continue advocacy activities to support ratification of MP14
- Update and publish factsheet
- Update Best Practices Guide (Edition 8 - 2023) with de-escalation techniques and examples for airlines
- Participate with other stakeholders in public awareness campaigns
- Review reports of mental distress events to raise awareness of issue.

<https://www.iata.org/en/policy/consumer-pax-rights/unruly-passengers/>



Safety Connect

Keeping you connected

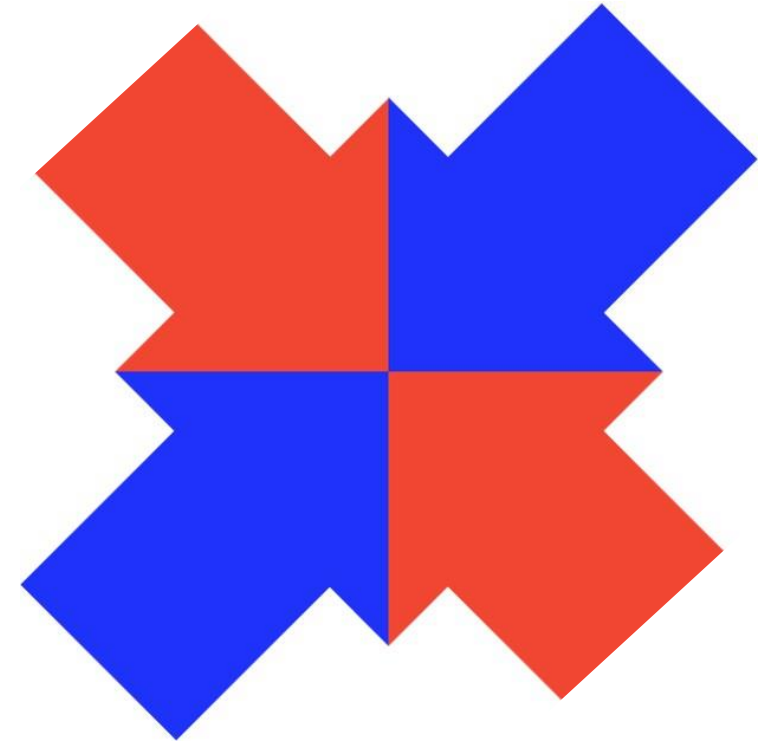

Safety Connect

A "safe space" for airline safety teams:

- Discussions
- Resources
- Peer to peer networking
- Identify new risks
- Ongoing challenges
- Regulatory interpretation

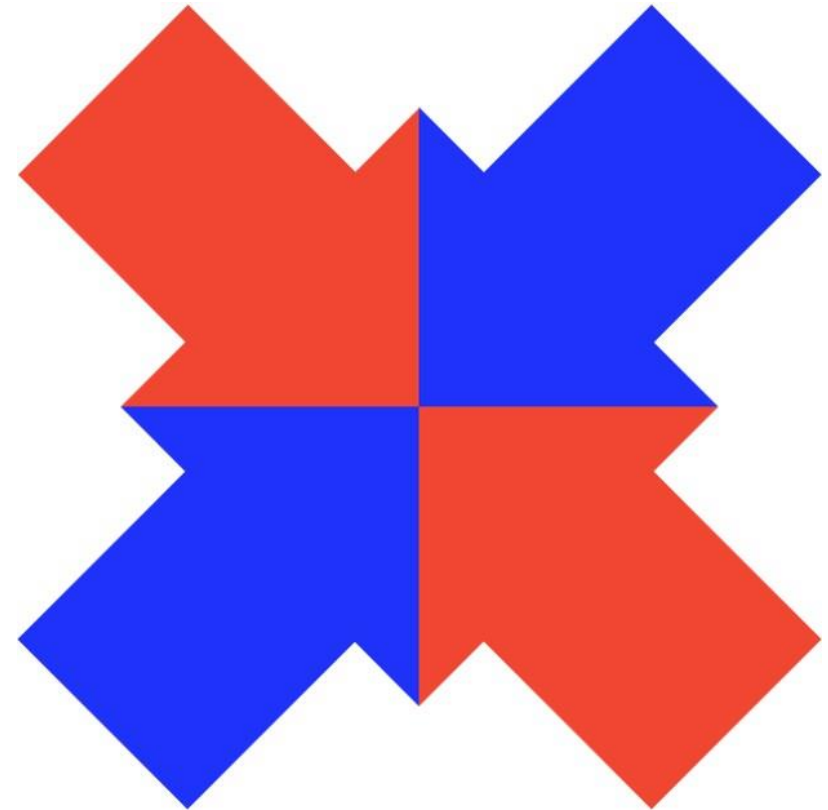



Jonathan Jasper 4/20 8:25 AM

3 2 @

[Cabin1](#) [Cabin2](#) [Cabin3](#) [Cabin4](#) The IATA Cabin Ops Safety Conference takes place in Lisbon, Portugal from 14th to 16th June. The agenda includes workshops on Turbulence Management, Safety Management in Cabin Ops, and Cabin Crew mental health and wellbeing.

There is a significant reduction in the registration fee for IATA member airlines and you can view the agenda by selecting the COSC2022 tab at the top of this channel. We really hope you can join us and add your input and experiences to our discussions. [IATA - Cabin Ops Safety](#)
[See more](#)



Cabin Ops Safety Conference

The IATA Cabin Ops Safety Conference places cabin operations as an integral and vital part of the airline operational safety spectrum.

www.iata.org

4 replies from [Carlos Mouzaco Dias](#) and [Renata Garcia_Renata Garcia Borges](#)



Grainne Healy (Guest) Yesterday 11:12 AM

See you there looking forward to meeting everyone

Reply

Today



Timothy Hill (Guest) Tuesday 11:09 AM

1

Hi everyone I hope you're all well. Can anyone share a contact in American Airlines cabin crew safety training please? Many thanks, safe flying, Tim.

Collapse all



Jonathan Jasper Tuesday 11:48 AM

1

I have asked someone for help Timothy, will let you know as soon as I hear back



Timothy Hill (Guest) 4:28 AM

Thanks [Jonathan Jasper](#) much appreciated!

Reply





IATA Safety Connect

Home

Discussions

Cabin-Safety

Flight safety

Cargo safety

Ground Operations

Technical Operations

IOSA

Safety Risk

IATA - What can we do to...

Recycle bin

Edit

+ New Send to Promote Page details Immersive Reader Analytics



Cabin Safety

Jonathan Jasper
Senior Manager Cabin Safety

Contact us



Home



Join conversation (TeamSite)



Cabin_safety@iata.org



Add a risk to the IATA Safety Risk Management Framework



COSTF members only

∨ Cabin Operations Safety Conference

∨ Cabin Operations Safety Risk Assessments

∨ Cabin Operations Safety Best Practices

∨ Regulations and Standards

∨ IATA Resources



Join now! (airlines only)



Accessibility

Are we making progress?



Cabin crew mental health

New focus and attention



Cabin crew mental health and wellbeing

Why should we be concerned?

Is this a safety issue?

What should we include in our assessments?

How can we prove our response is having a positive effect?

What are the best practices we should work towards?



Is this topic regulated?



Safety data

Incident Data Exchange (IDX)





GADM Membership Overview

Last Update (UTC)
Jun 05, 2022 07:07:52 PM

219 GADM Members 219 IDX Participants 0 FDX Participants

Active Members per Program

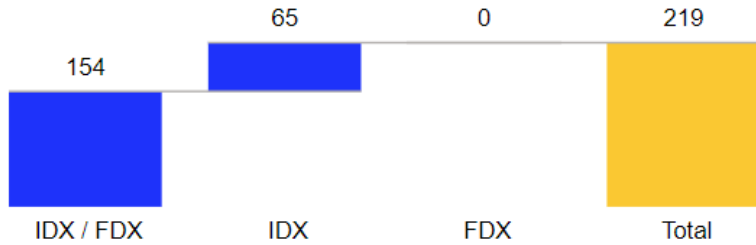

AFI	CIS	LATAM/CAR	NAM
ASPAC	EUR	MENA	NASIA

IDX FDX

GADM Participant

GADM Participant	Region	Country	GADM Programs	Member IATA
Tassili Airlines	Middle East & North Africa	Algeria	IDX	✓
Aerolineas Argentinas S.A.	Latin America & The Carribean	Argentina	IDX / FDX	✓
Flybondi	Latin America & The Carribean	Argentina	IDX / FDX	✓
Virgin Australia International	Asia Pacific	Australia	IDX	✓
Ewat Gmbh	Europe	Austria	IDX	✓
Gulf Air B.S.C. (C)	Middle East & North Africa	Bahrain	IDX / FDX	✓
Boliviana De Aviacion (Boa)	Latin America & The Carribean	Bolivia, Plurinational State of	IDX / FDX	✓
Air Botswana	Africa	Botswana	IDX / FDX	✓
Absa - Aerolinhas Brasileiras S.A	Latin America & The Carribean	Brazil	IDX / FDX	✓
Azul Linhas Aereas Brasileiras	Latin America & The Carribean	Brazil	IDX / FDX	✓
Gol Linhas Aereas S.A.	Latin America & The Carribean	Brazil	IDX / FDX	✓
Modern Transporte Aereo De Carga Sa	Latin America & The Carribean	Brazil	IDX / FDX	✓
Tam Linhas Aereas S.A.	Latin America & The Carribean	Brazil	IDX / FDX	✓
Bassaka Air Limited	Asia Pacific	Cambodia	IDX / FDX	✓
Air Canada	North Atlantic & North America	Canada	IDX	✓
Air Transat	North Atlantic & North America	Canada	IDX / FDX	✓
Cargojet Airways Ltd.	North Atlantic & North America	Canada	IDX / FDX	✓
Sunwing Airlines Inc.	North Atlantic & North America	Canada	IDX	✓
Swoop Inc.	North Atlantic & North America	Canada	IDX	✓
Westjet	North Atlantic & North America	Canada	IDX	✓
Westjet Encore Ltd.	North Atlantic & North America	Canada	IDX	✓



Back to Home Page

Cabin Smoke/Fire/Fumes

Incident rates calculated per

10,000

flights

Last updated on 06-06-2022
based on active IDX membership
Is Rule of 3 Active? **Yes**



Last 21 Months (Calendar)

9/1/2020 - 5/31/2022

Average IDX Incident Rate in selected timeframe

All IDX Operators 0.62

Region of Operator 0.07

Asia Pacific

See Location and Aircraft Details

Incident Category

All

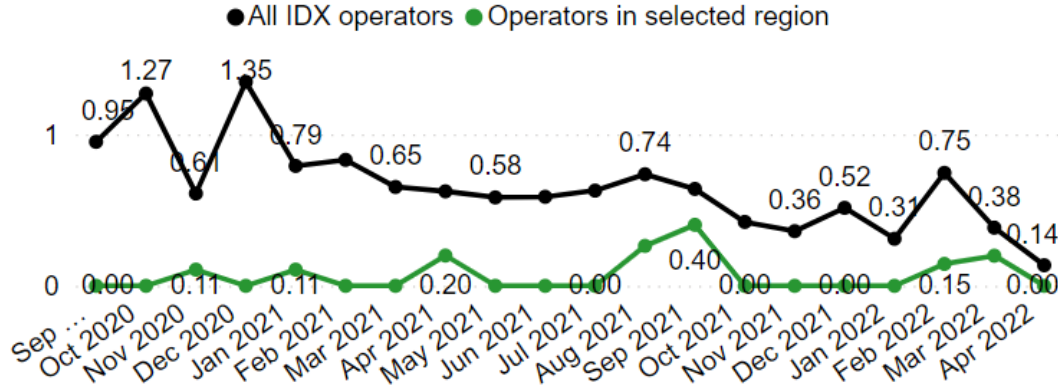

Area of Incident and Frequency

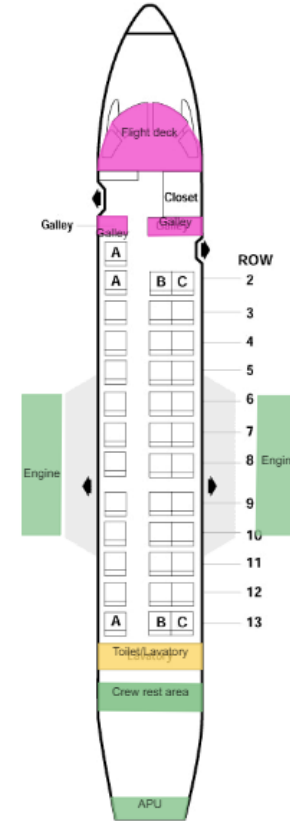

Color coding based on the frequency out of total events submitted in IDX:
● <5% ● <10% ● <14% ● >14%

Cabin Incident Area

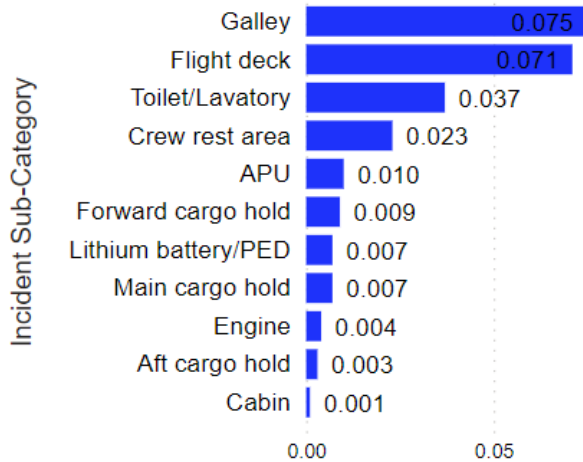

Correlated Incident Category

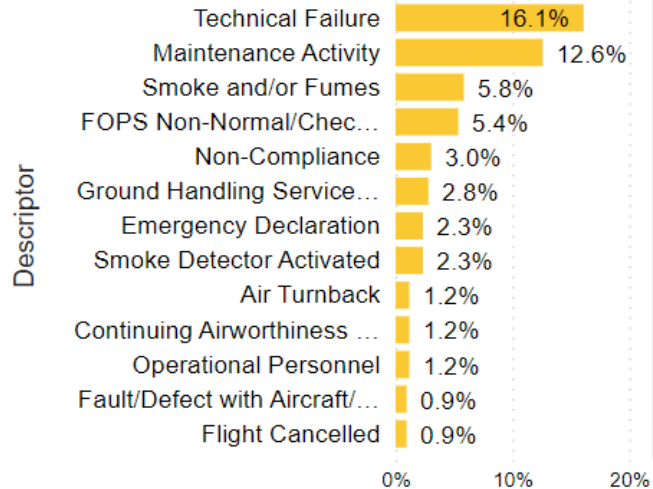

YOUR Data drives OUR decisions



Good quality data is vital



Global representation



All aspects of operations should be submitted

IOSA



IOSA CAB Standards

Revisions made for ISM 16

- CAB 3.2.10 Trolleys
- CAB 3.2.4A Door Procedures
- CAB 3.4.1 Passengers requiring special handling
- CAB 3.4.2 Unruly Passengers
- Some Fatigue related ISARPS under final review



Risk based IOSA Project



The Business Model

Customer Expectations

Challenge

Affordable and value-add audits
User friendly access to current information

Solution

Audit process tailored to airline
Improved user interfaces

AO Accreditation Model

Challenge

Financial autonomy and sustainability
Auditor standardization and performance
Ability to innovate

Solution

Phase out AOs and insource production of audits
Recruit and train IOSA Auditors on freelance basis

Organization

Challenge

Production capacity
Digital Maturity

Solution

Transform and scale up IOSA organization
Develop IT infrastructure



Transition Plan

Transition Plan supports timely scaling up and mitigation of risks

- 2022 trial audits will be performed to test audit methods and audit management process
- AOs will remain until end of 2024 to perform conventional IOSA audits
- 2025 onwards fully insourced model supporting over 200 IOSA audits per year

Projected Transition

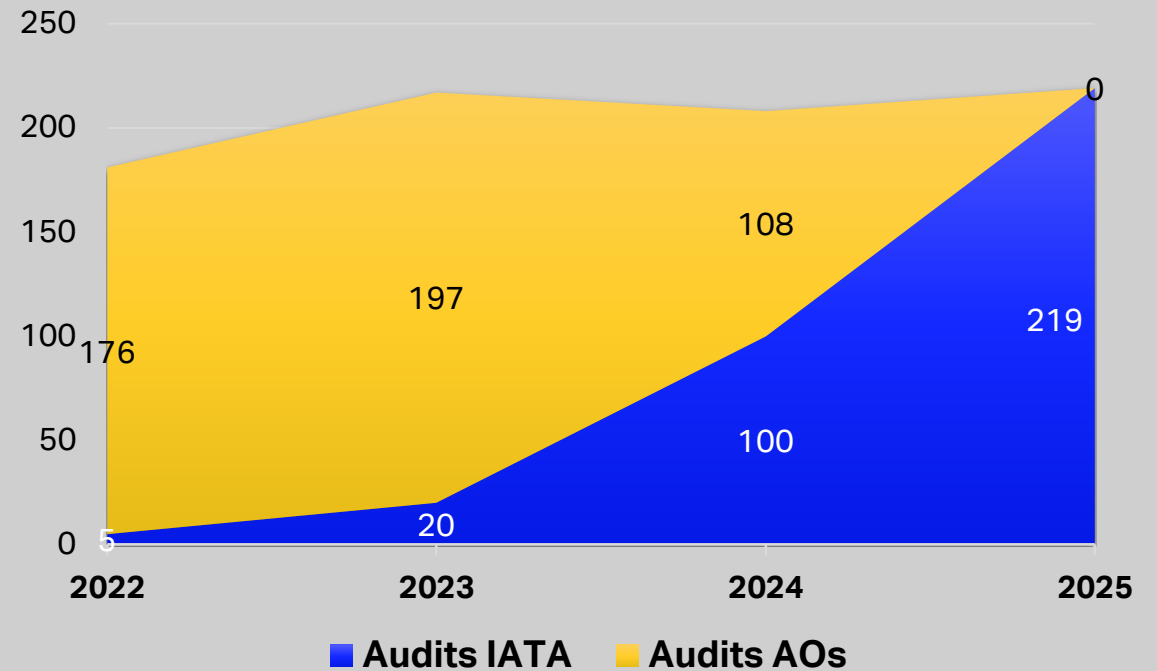

Risk-based Audit Scoping

Audit scope will be reduced to critical standards, freeing up valuable auditing time



Industry Standards
prioritization

Operator Audit Scoping

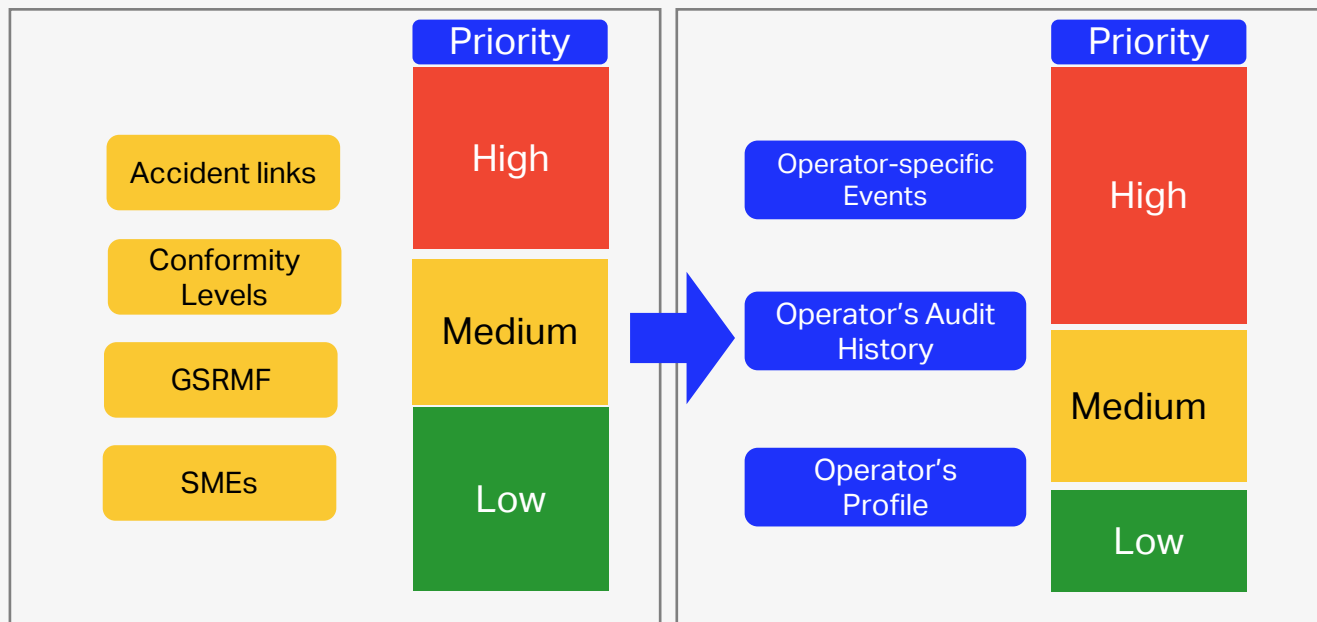

- ✓ Tailored audit scope for each Operator
- ✓ Frees up time to increase depth of auditing of high priority requirements
- ✓ Allows for maturity assessment of critical systems and programs

Risk-based Audit Scoping

Away from the one-size fits all approach

Audit Scoping	IOSA	Risk-Based IOSA
<ul style="list-style-type: none">Worldwide runway excursion rate has been increasing.	<ul style="list-style-type: none">All ISARPs are audited regardless of their universal criticality.	<ul style="list-style-type: none">ISARPs prioritized in regular intervals. In this example, ISARPs related to runway excursions are identified as high priority and audited in-depth.
<ul style="list-style-type: none">Operator has been demonstrating conformity with a non-critical ISARP for several consecutive audits.	<ul style="list-style-type: none">All ISARPs are audited regardless of their criticality for the operator.	<ul style="list-style-type: none">Audit scope tailored to Operator's operating profile and audit history.ISARPs with low criticality may be audited at lower frequency to allow focus on high-criticality ISARPs.

Maturity Assessment

Example

Maturity Assessment



FLT 2.2.14

The Operator shall ensure flight crew members complete training and, when applicable, an evaluation in crew resource management (CRM), including Threat and Error Management, using facilitators that have been trained in human performance and human factors principles.

IOSA

Assessment Method (on each ISARP)

Conformity

Nonconformity

Risk-Based IOSA

Assessment Method (on selected ISARPs and Programs)

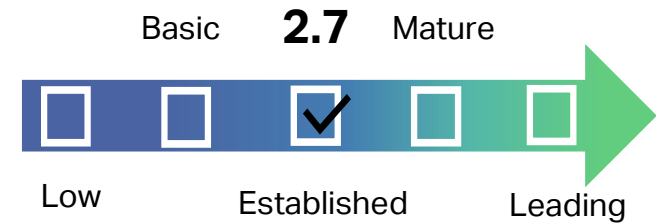

Benefits of Risk-based IOSA

 Tailored and reduced Audit scope focusing efforts where needed the most

 Improved audit methods through maturity evaluation

 Improved management and standardization of Auditors

 Safety insights captured to deliver safety improvements and reduction of global accident rates

 New insights through improved audit report

 Long term sustainability of IOSA program through direct management of insourced products

Best Practices

... given as alms
...ve base bri(m)b- d
man trafficking no
illegal practice of pro
s for the purpose
forms of



What's new in Edition 8 (2023)

De-escalation techniques and
recommendations



Distribution

IATA member airlines

- Join IATA Safety Connect
- Request a copy using the online form
- One copy per airline representative
- Currently no limit on number of copies provided

Non-IATA members and other organizations or individuals

- Purchase from the IATA online store
- One copy per purchase





Thank you

Jonathan Jasper (JJ)

jasperj@iata.org

Cabin_safety@iata.org

www.iata.org





ICAO

SAFETY

NO COUNTRY LEFT BEHIND



SAFETY MANAGEMENT IN CABIN OPERATIONS

Martin Maurino M.Eng

Technical Officer, Global Aviation Safety - ICAO

IATA COSC, 14-16 June 2022

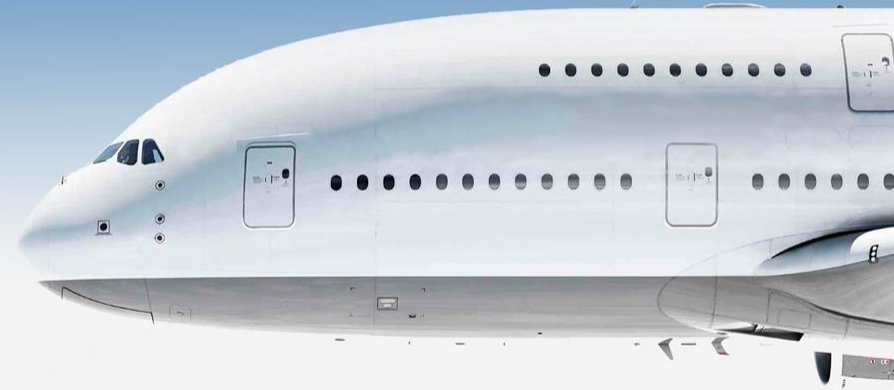



Overview

- ICAO guidance on safety management in cabin ops
- Cabin Ops & SMS
- Reporting
- Safety performance management
- ICAO Cabin Safety on-going and future work



ICAO

SAFETY

NO COUNTRY LEFT BEHIND



ICAO Cabin Safety Group





Safety Management in Cabin Ops

- ICAO standards on SMS for “service providers”
 - including international commercial air transport operators
- State safety programme (SSP) implementation
- New guidance aims at including cabin ops
 - in both SMS & SSP
- Addresses cabin ops aspects in all SSP/SMS components
 - Safety policy and objectives
 - Safety risk management
 - Safety assurance
 - Safety promotion





Cabin OPS & SMS

- Safety policy and objectives
 - including key cabin safety personnel and role in SRB and SAG
- Safety risk management
 - identifying hazards in cabin ops, SRAs and mitigations
- Safety assurance
 - including SPM in cabin ops and change management
- Safety promotion
 - training & education and safety communication to cabin crew
- Contracted activities
- Roles of senior management and front line personnel
- SMS for small operators





Reporting

- Safety reporting systems
 - mandatory & voluntary
- Reasons for writing a report
 - including to aid in decision-making and promote change
- Issues related to reporting
- Writing a meaningful report
- Positive safety culture and reporting
- Sample report templates
- Additional guidance
 - Memory aid for effective report writing
 - Sample cabin safety report
 - Fields suggested in electronic cabin safety reports





Writing Meaningful Reports

- **Factual**
 - avoids emotive language and assumptions, remains objective and unbiased
- **Clear & concise**
 - easy to read and interpret, using known terminology
- **Constructive**
 - offers solutions and serves useful purpose
- **Courteous**
 - respectful, considerate, business-like, professional
- **Complete, structured and ordered**
 - contains all relevant info





Accuracy in Reporting: In-flight Fire

Information	Vague	Specific
Location	Back of the cabin	Aft galley
Intensity	Not too bad	Orange flames of approximately 10cm observed
Source	Don't know	Unknown, oven in aft galley suspected
Action	Everything we could do	The cabin crew number stationed at R-1 fought the fire



Memory Aid for Effective Reporting

POISE

Polite	Courteous	Use professional style and language. Do not apportion blame.
Ordered	Complete structured and ordered	Tell the sequence of events in correct order.
Improvement	Constructive	Provide suggestions for preventing it from happening again.
Short	Clear and concise	Keep it simple. Provide sufficient information but avoid: <ul style="list-style-type: none">• opinions;• emotions; and• jargon.
Event	Facts	What happened? When? Where? Who was involved? What were the actions taken and the results thereof?



Cabin Safety Report (CSR)				
Reporter name	[Name/employee number]			
Local date of departure	Flight number	Route: from/to	Phase of flight	Time of incident
/ /		/		:
Title of report — <i>The subject of the issue/incident/accident/concern.</i>				
Occurrence details — <i>Describe what happened.</i>				
Actions taken — <i>What did you do?</i>				
What was the result? — <i>Was the situation contained?</i>				
Were the procedures, equipment and training effective? — <i>What could you suggest for improvement?</i>				
Other relevant information — <i>Include details of other crew members involved, witnesses, potential causes or contributing factors, etc.</i>				



ICAO Sample Report Templates

- Unruly passengers and reporting of incidents
 - Aviation Security Manual (Doc 8973 — Restricted)
- Occurrence reporting forms for investigations
 - Manual on the Investigation of Cabin Safety Aspects in Accidents and Incidents (Doc 10062)
- Standardized smoke and fumes reporting form
 - Guidelines on Education, Training and Reporting Practices related to Fume Events (Cir 344)
- Trafficking in persons on board reporting form
 - Guidelines for Reporting Trafficking in Persons by Flight and Cabin Crew (Cir 357)



Safety Performance Management

- Monitoring and measuring safety performance
- Safety performance indicators (SPI) related to cabin ops
 - Measuring processes versus outcomes
 - How to define SPIs
 - Selecting appropriate SPIs
 - Sample SSP SPIs related to cabin ops
 - Sample SMS SPIs related to cabin ops
- Safety performance targets (SPT)
- Link between SPIs, SPTs and safety objectives
- Comprehensive approach to safety performance management
- Sample SPI form





Selecting Appropriate SPIs



- Why measure this safety issue?
 - This should be justified by data analysis and safety risk assessment
- Can safety issue be measured and monitored?
- Does operator have capability in terms of tools, personnel and funds to monitor SPI?
 - operator flying aging aircraft may not be able to obtain same level of info regarding parameters from FDM than one with newer generations
 - e.g. if seatbelt sign was illuminated during turbulence or arming status of doors in event of ISD
- By what means can data be captured?
 - e.g. voluntary cabin crew reporting, line checks or audits of cabin crew training programme



Sample SPIs in Cabin Ops

- **Outcome related SPIs**
 - inadvertent slide deployments
 - turbulence-related injuries
 - smoke or fire on-board
 - cabin crew incapacitation / unable to perform safety duties
 - events involving lithium batteries (fire / smoke / overheat)
 - medical emergencies on board
 - equipment failures
- **Activity/process-related SPIs**
 - quantity of audits performed in a given timeframe
 - number of operator personnel trained in a given timeframe on a particular subject
 - rate of voluntary occurrence reports





Links between SPIs, SPTs and Safety Objectives

	Safety performance indicator	Safety performance target	Safety objective
Outcome-related	[Number] turbulence-related injuries per [number] hours flown.	<ul style="list-style-type: none"> • Less than [number] turbulence-related injuries per [number] hours flown in [year 1]. • Less than [number] turbulence-related injuries per [number] hours flown in [year 2]. • Less than [number] turbulence-related injuries per [number] hours flown in [year 3]. 	Reduce turbulence-related injuries.
Activity-related	[Number] cabin crew line checks completed [month].	<ul style="list-style-type: none"> • [Minimum number] of cabin crew line checks completed in [month 1]. • [Minimum number] of cabin crew line checks completed in [month 2]. • [Minimum number] of cabin crew line checks completed in [month 3]. 	Increase cabin crew adherence with operator procedures.



Links between SPIs, SEIs and SPTs

Safety performance indicator	[number] of inadvertent slide deployments per [number] operations.
Safety enhancement initiatives	<ul style="list-style-type: none">▪ Acquisition of new emergency exit trainer device.▪ New recurrent training module for cabin crew members over the next year on door operation.
Safety performance target	<ul style="list-style-type: none">▪ Maintain no more than 8 inadvertent slide deployments per 10,000 operations by 2022.▪ Maintain no more than 6 inadvertent slide deployments per 10,000 operations by 2023.▪ Maintain no more than 4 inadvertent slide deployments per 10,000 operations by 2024.
Safety objective	Reduce ground and in-flight damage events at the operator.



PART A: INDICATOR IDENTIFICATION

1. INDICATOR

Enter a name for the indicator.

2. DESCRIPTION

Enter a brief description for the indicator.

3. SAFETY OBJECTIVE

List the safety objective(s) the indicator supports.

PART B: INDICATOR SPECIFICATIONS

4. AREA OF OPERATIONS

For example, cabin operations.

5. PROJECT OR PROGRAMME

If applicable, identify the specific project or programme to which the indicator is related (e.g. training).

6. INDICATOR TYPE

The indicator is: activity-related (predictive or leading) OR outcome-related (reactive or lagging)

7. RATIONALE

Explain how the indicator is related to the safety objective above and what its measurement supports.

8. LIMITATIONS

Describe the scope of the variable or entity that the indicator measures.

9. DEFINITION OF TECHNICAL OR SPECIFIC TERMS

If applicable, provide a definition of technical or specific terms.

10. CALCULATION METHOD/FORMULA

PART C: DATA

In the table below, provide information about the data supporting the measurement of the indicator.

11. DATA SET(S)	12. AVAILABILITY	13. DISAGGREGATION LEVEL	14. PROVIDER	15. CUSTODIAN



On-going & Future Work

- **Manual on Effective Safety Oversight in Cabin Operations**
 - including training approvals, en-route inspections, review of SRAs
- **Critical incident response programme (CIRP) for cabin crew**
 - including design, implementation, peer support, and training
- **Innovation in Cabin Crew Training**
 - use of VR and other technology to enhance training
- **Lithium battery fire procedures**
 - EFB fires in flight deck and fire containment bags
- **Managing cabin dynamics (unruly pax in post-pandemic context)**





For more information, visit:
www.icao.int/cabinsafety

Email:

mmaurino@icao.int

THANK YOU!

MEXICO CITY
(NORTH AMERICA AND CARIBBEAN)

LIMA
(SOUTH AMERICA)



Aviation: Gatekeepers Against Human Trafficking

Presentation by: Emily Manduku

Flight Operations Inspector-Cabin Safety - KCAA

We have our #eyesopen

WATCHING FOR THE SIGNS OF
24.9 million
victims of

Human trafficking

FORCED LABOR - ORGAN THEFT - SEXUAL EXPLOITATION



Aviation is the "business of freedom". Unfortunately, air services can also be misused by criminals who profit from the trade in humans. Our industry is committed to have its eyes open to do what we can to help governments and law enforcement to tackle this issue.

Playing our part



Raise Awareness



Develop Airline Guidance



Encourage Reporting
Hotline Development



Training
for Airline Staff



Create Partnerships



Mobilize the Industry

www.iata.org



- Background
- Personal Encounter
- Why talk about Human trafficking?

Due to the clandestine nature of this heinous crime, accurate statistics are difficult to come by, in fact, the United Nations refers to it as *“the hidden figure crime”*

01

In 2019, over 4.7 billion passengers flew safely on over 20,000 city-pairs.



Statistics on Human Trafficking

02

According to the United States (US) State Department, human trafficking is the world's second largest and fastest growing criminal activity after drug trafficking.

03

A study done by the United Nations Office on Drugs (UNODC) revealed that around two-thirds of trafficked persons had passed across at least one international border.

As aviation is increasingly becoming affordable, the speed and efficiency makes the industry attractive to those who want to exploit and deny vulnerable people their freedom.



STOP

Human Trafficking

The internet is awash with websites and apps that monitor slave produced goods, for instance,

www.slaveryfootprint.org

This one especially, has a survey that seeks to know your spending behaviour on what you do, eat, wear, where you go and it will tell you how many slaves ultimately support you.

Common Causes of Human Trafficking



Covid-19 Crisis

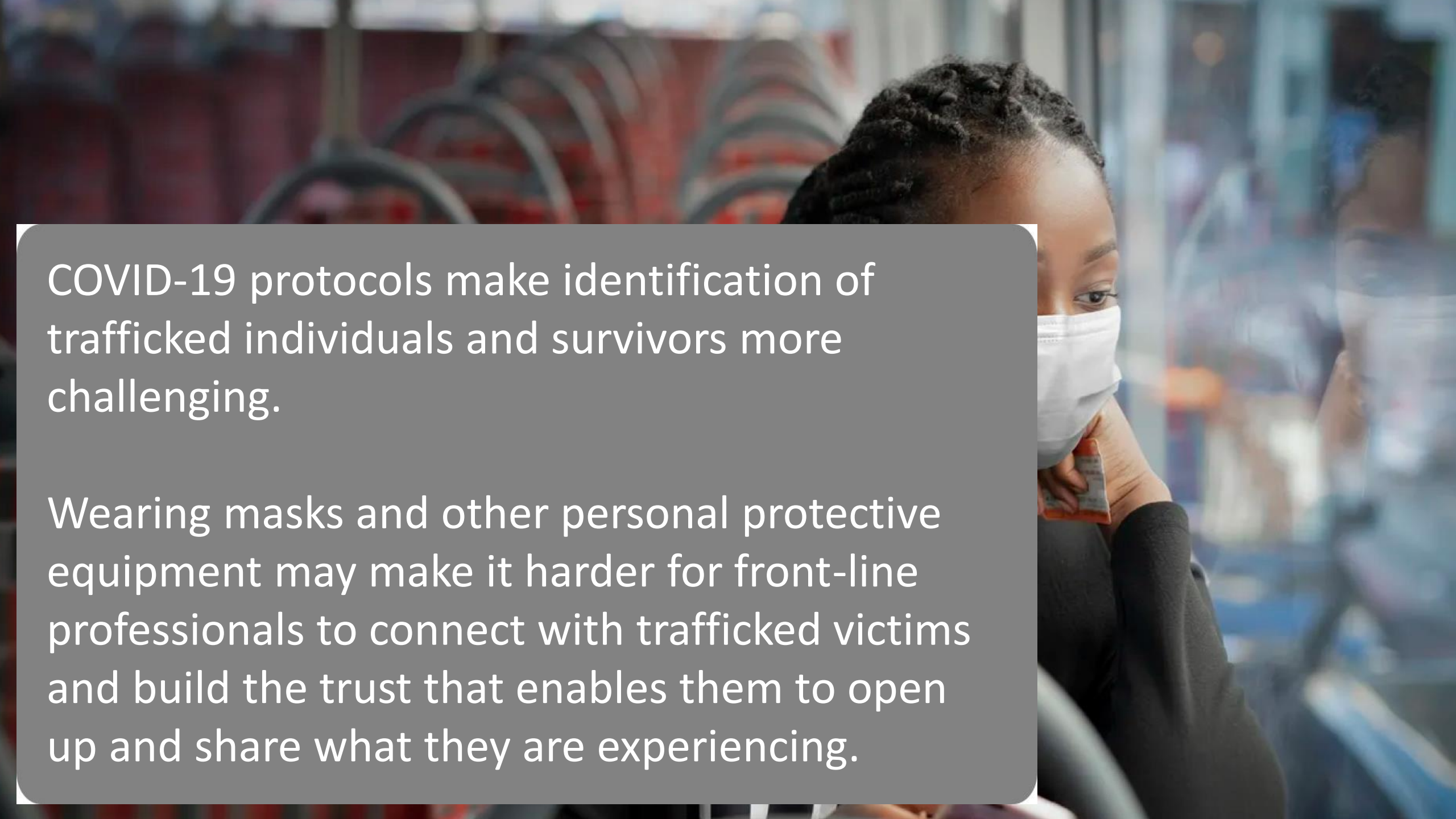

As a result of the COVID-19 health crisis, the world is today facing an impending economic crisis that will increase unemployment globally, widening social and economic inequalities, and impacting the landscape of trafficking worldwide.

A woman with dark hair in braids, wearing a white surgical mask, is shown in profile. She is holding a small orange object, possibly a pill or a small container, near her mouth. The background is a blurred hospital or clinical setting with metal railings and other people in the distance.

COVID-19 protocols make identification of trafficked individuals and survivors more challenging.

Wearing masks and other personal protective equipment may make it harder for front-line professionals to connect with trafficked victims and build the trust that enables them to open up and share what they are experiencing.

The lifting of the COVID-19 protocols that hinder identification of human trafficking victims should be implemented as we continue the restart of air operations.

01

While the issue of human trafficking is well known, some airlines are still cautious about getting cabin crew to report suspicions for fear of being accused of bias, discrimination and generalization, especially where authorities don't appear to act on their suspicions.

02

Detection at the transport phase is crucial in order to save many victims. Through cooperation with airlines, airport law enforcement authorities can better identify and refer victims of trafficking. Estimates suggest that, internationally, only about 04% survivors of human trafficking cases are identified, meaning that the vast majority of cases of human trafficking go undetected.

03

When provided in a timely manner, passenger data could also be a key tool for risk assessment and early identification of both traffickers and victims while flagging the *'red-routes'*

Aviation Industry Solutions

It is everyone's responsibility to add their voice and step-up the tempo to curb this nefarious business.

ICAO /IATA Training in collaboration with the UNOCHR developed a great free-of-charge eLearning tool, for use by States and operators.



The Call For Action

How can your organization or an individual play a part in solving this global problem?

01

Learn the signs
(through training)

02

Implement a framework
for reporting suspicious
activity

03

Create Awareness

**Our business is more worthwhile, more meaningful when we
make an impact to those that we serve.**

“The world will not be destroyed by those who do evil, but by those watch them without doing anything”

-Albert Einstein (1879-1955)



Q & A

**Thank You
Asante Sana**



Crew Engagement

A wellbeing strategy for tackling constant change

Andrew Judge / Head of Cabin Services
Lisbon / June 2022





Andrew Judge

Head of Cabin Services at Xfly



xfly

› Xfly Bases



A new world of work

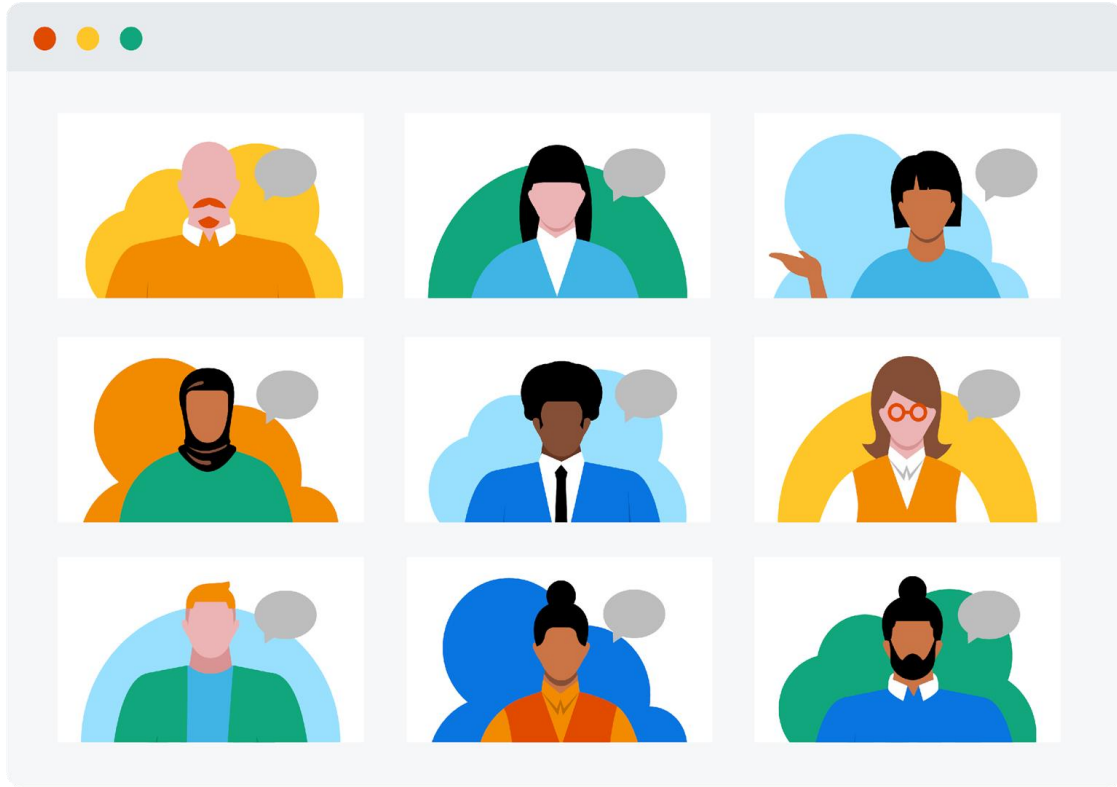

2020 changed us

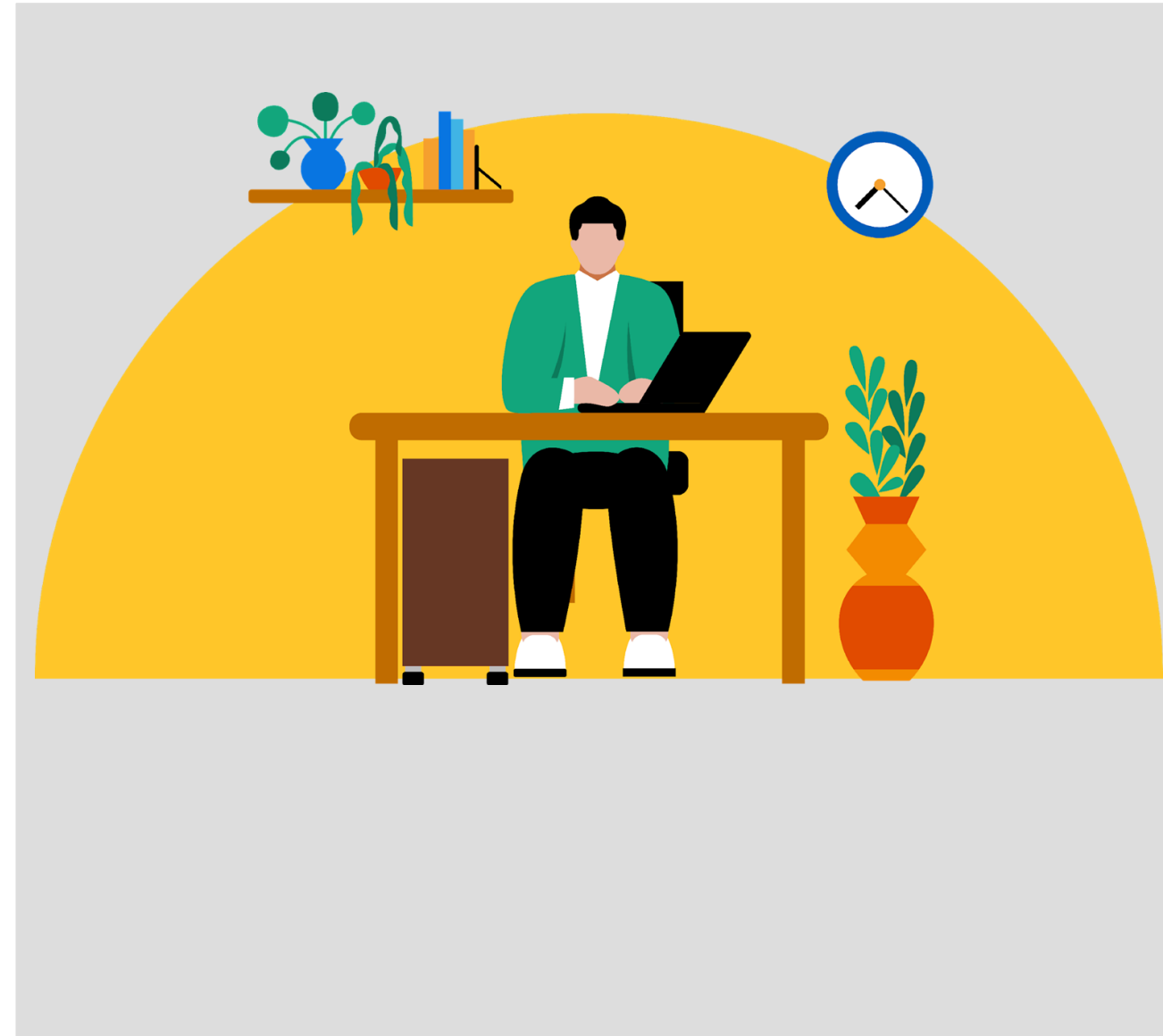

Employee Engagement



Give a **remote**
workforce a voice

Intelligent listening



Give a unique and powerful voice to **each employee**

Workday Peakon - Employee Voice

SELECTED SEGMENTS 8 segments		Engagement	Accomplishment	Autonomy	Environment	Freedom of Opinions	Goal-Setting	Growth	Management Support	Meaningful Work	Organisational Fit	Peer Relationships	Recognition	Strategy	Workload
SEGMENTS	CORE OUTCOME	DRIVER	DRIVER	DRIVER	DRIVER	DRIVER	DRIVER	DRIVER	DRIVER	DRIVER	DRIVER	DRIVER	DRIVER	DRIVER	DRIVER
Denmark <small>Country</small> 31 👤	8.6	8.2	7.4	7.4	7.3	9.2	7.5	7.9	8.7	8.2	8.0	7.1	8.3	8.1	
CPH <small>Base</small> 19 👤	8.7	8.5	7.9	8.0	7.6	9.4	8.0	8.1	9.2	8.7	8.4	7.7	8.2	7.9	
ARN <small>Base</small> 19 👤	8.8	8.3	6.6	9.2	8.4	8.9	8.2	8.8	9.0	8.7	8.5	8.1	8.7	8.7	
Nasibe Cesilia Sadeghi <small>Manager (All reports)</small> 26 👤	8.6	8.4	7.2	9.2	8.3	8.9	8.1	8.9	8.7	8.7	8.5	7.3	8.7	8.9	
NCM <small>Agency</small> 41 👤	5.3	6.3	5.9	7.1	6.4	8.2	5.4	5.9	7.6	5.9	7.9	5.5	5.1	6.3	
Elisabeth Ohl <small>Manager (All reports)</small> 45 👤	5.5	7.0	5.9	7.3	6.7	8.7	5.7	6.4	8.0	6.4	8.2	5.7	5.8	6.6	
5 years - 10 years after starting <small>Start date</small> 24 👤	5.8	6.6	6.5	7.0	7.2	8.2	6.8	6.7	8.1	6.2	7.9	6.3	5.2	6.3	
CCM+ <small>Rank/Title</small> 17 👤	5.8	6.7	6.4	7.6	6.8	8.6	5.4	6.1	7.7	6.4	8.4	6.0	6.2	6.1	

Comments

Conversation

Employee



The overall business goals and strategies set by senior leadership are taking Xfly in the right direction.

Score: 10 17 February

Yes. I believe so. My own professional background in sales within global commercial aviation, helps me to understand all steps that are going on in the company and it helps me to give positive feedback to other colleagues helping at the same time, to destroy negative rumors about our company.

[1 acknowledgement](#)

Elisabeth Oll

EO

Giving positive feedback to colleagues is so important and sometimes a bit overlooked! Thank you so much for bringing this with you from your other experiences!

Reply sent 3 months ago

Highlighted



I have the opportunity to do challenging things at work.

17 February • Score: 10 • Challenging > Accomplishment •

Yes, I think so. When we have on board 88 passengers travelling on SAS network, we deal with many kind of passengers. Many of them are CEOs of very important brands, and many have executive positions. To have them on board and frequently is really challenging and if you love what you do, then you have the opportunity to do challenging things at work. In my personal case I have had the opportunity to motivate some business people to apply for the SAS corporate program. Many of them did not know about it. To explain benefits in a professional way and in a very short time, is really challenging. And I feel happy doing so.

[2 acknowledgements](#)



Acknowledge



Conversation

Closing the Feedback Loop

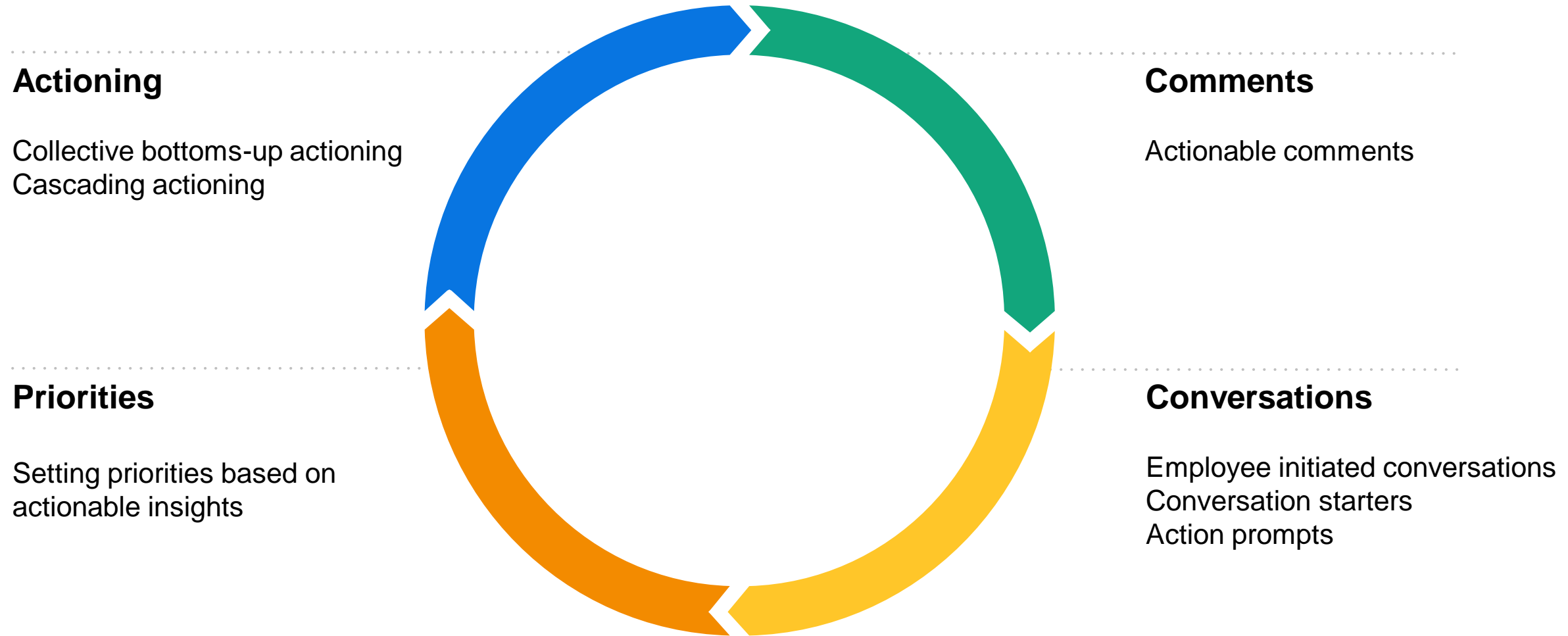

Actioning

Collective bottoms-up actioning
Cascading actioning

Comments

Actionable comments

Priorities

Setting priorities based on
actionable insights

Conversations

Employee initiated conversations
Conversation starters
Action prompts

What I need to feel engaged ...

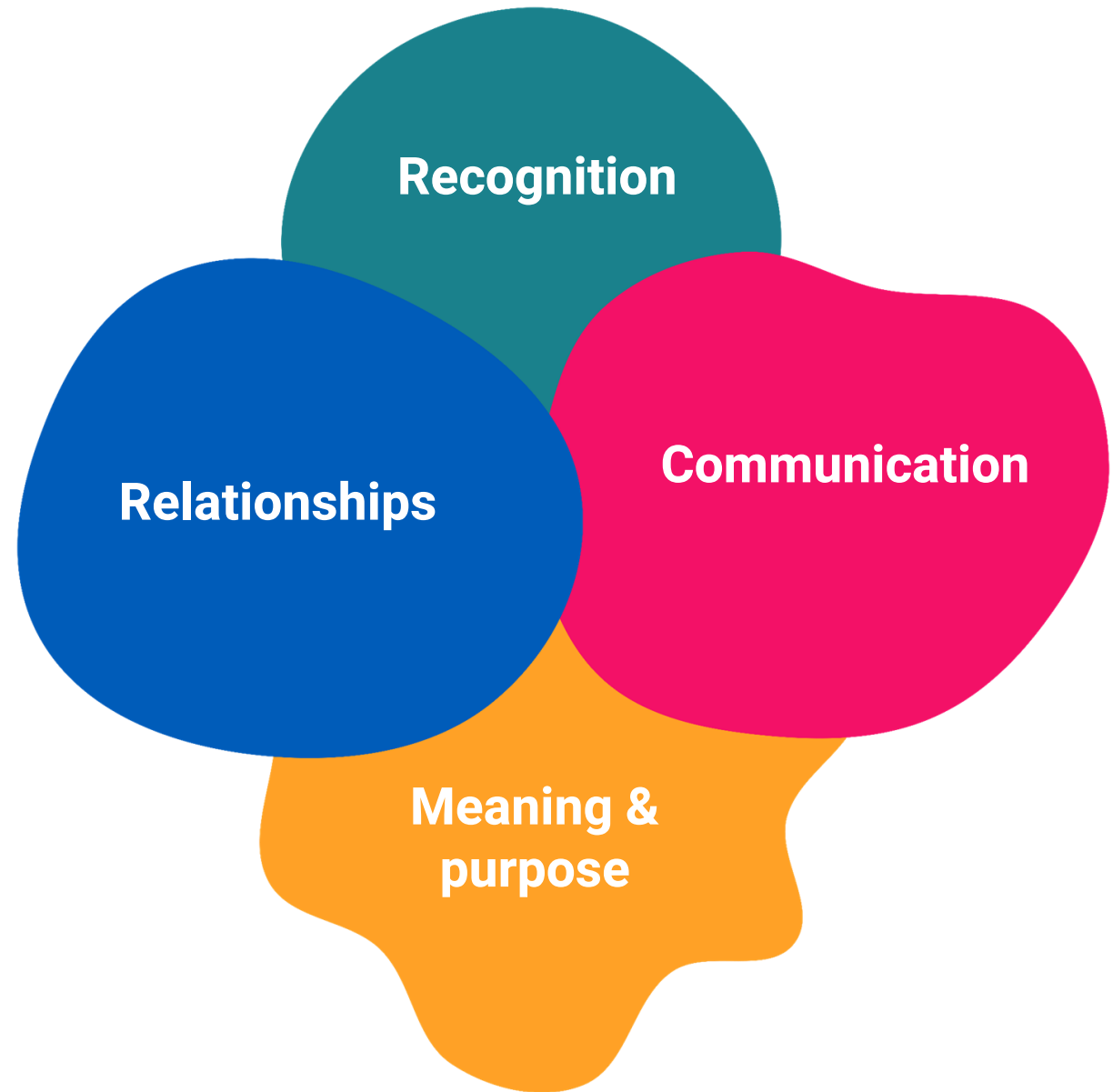

› Higher level focus



Constant change is the new norm -
adapt to evolving business needs

Deliver remarkable employee
experiences - ***attract, understand
and retain people***

› **Takeaways**

- **Overcommunicate**
- **Top-down support**
- **Segmentation of data**
- **Recognition**
- **Regular feedback improves Safety Culture**



is our
super-
power

**Practical Manuals
and Quick Reference Handbooks
for Cabin Crew**

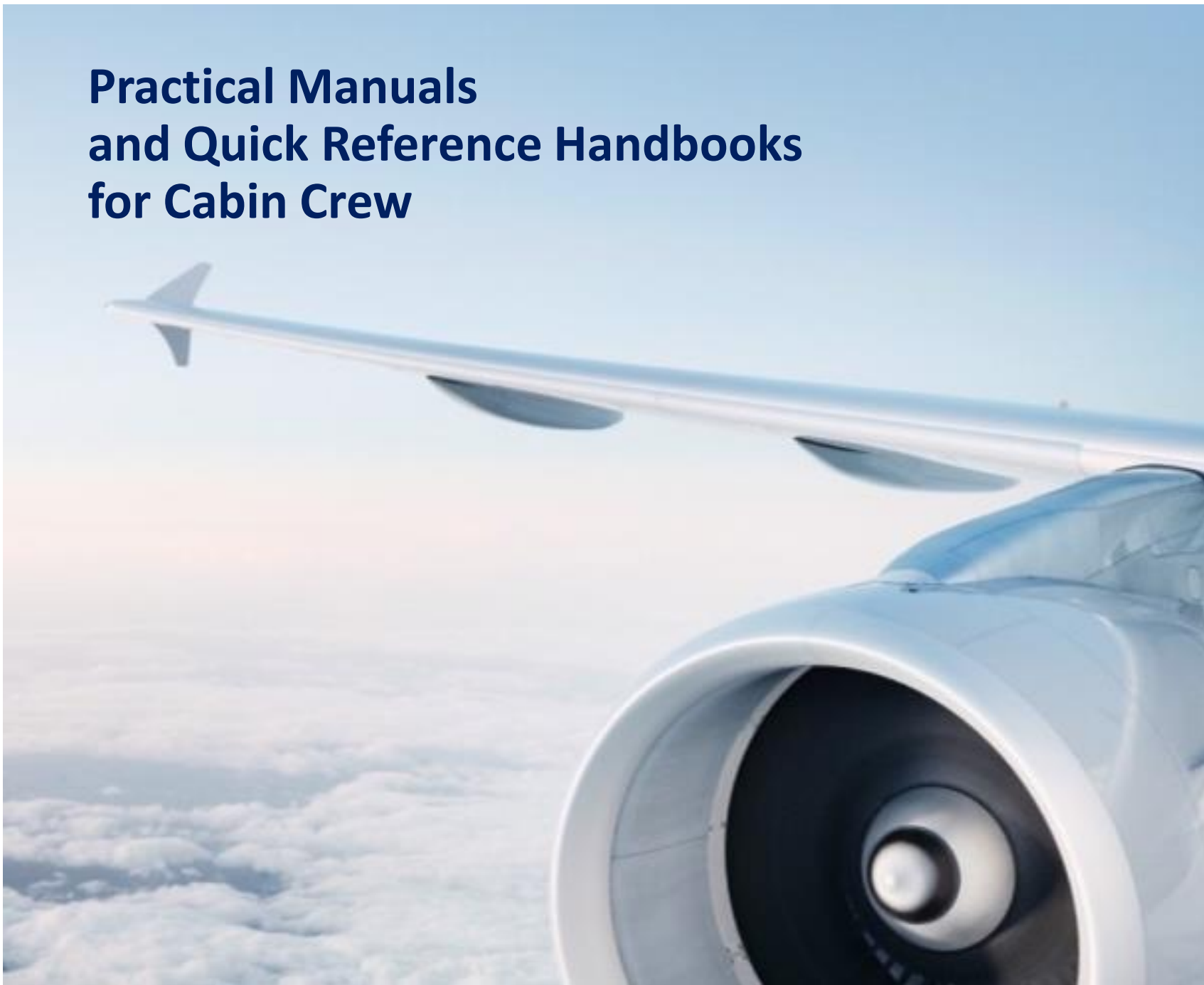

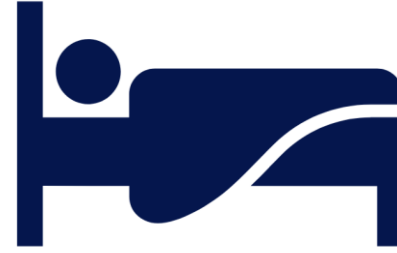





DOCUMENTS
PASSPORT.....CHECKED
VISA.....AS REQ
CREW ID.....CHECKED
CABIN CREW ATTESTATION.....CHECKED
COVID VACCINATION.....AS REQ

ELECTRONICS
CABIN MOBILE DEVICE.....CHECKED
SMARTPHONE.....CHECKED
CHARGERS.....CHECKED
ADAPTER.....AS REQ

HYGIENE
TOOTHBRUSH.....CHECKED
TOOTHPASTE.....CHECKED
DENTAL FLOSS.....CHECKED
SHAMPOO.....CHECKED
BRUSH.....CHECKED
SUNSCREEN.....CHECKED
COSMETICS.....CHECKED
DISINFECTANT.....CHECKED
FACE MASK.....CHECKED

OTHERS
KEYS DOOR/CAR.....CHECKED
CREDIT CARDS/CURRENCY.....CHECKED
SUN GLASSES.....CHECKED
BAG.....CHECKED

UNIFORM
SHIRT.....CHECKED
SKIRT.....CHECKED
SCARF.....CHECKED
TIGHTS.....CHECKED

CLOTHES
UNDERWEAR.....CHECKED
BATHING SUIT.....CHECKED
PYJAMAS.....CHECKED
JEANS.....CHECKED
BLACK DRESS.....CHECKED
SHIRT.....CHECKED
RAIN JACKET.....CHECKED
HAT.....CHECKED
SHOES.....CHECKED
SOCKS.....CHECKED



AIRBUS A320 NORMAL CHECKLIST



BEFORE START

COCKPIT PREP.....COMPLETED
 GEAR PINS AND COVERS.....REMOVED
 SIGNS.....ON/AUTO
 ADIRS.....NAV
 FUEL QUANTITY.....CHECKED
 TO DATA.....SET
 BARO REF.....SET
 WINDOWS/DOORS.....CLOSED
 BEACON.....ON
 THRUST LEVERS.....IDLE
 PARKING BRAKE.....SET

AFTER START

ANTI ICE.....AS REQ

AFTER TAKEOFF

LANDING GEAR.....UP
 FLAPS.....RETRACTED
 PACKS.....ON
 BARO REF.....STANDARD SET

APPROACH

BRIEFING.....CONFIRMED
 ECAM STATUS.....CHECKED
 SEAT BELTS.....ON
 BARO REF.....SET
 MDA/DH.....SET
 ENGINE MODE SELECTOR.....NORMAL

LANDING

CABIN CREW.....ADVISED

BEFORE START

GEAR PINS, COVERS REMOVED | PM
 SIGNS ON / AUTO
 ADIRS NAV
 FUEL QUANTITY..... __ KG
 ALTIMETERS..... __, __ | BOTH
 WINDOWS./DOORS..... CLOSED | BOTH
 BEACON ON
 PARK BRK AS RQRD

AFTER START

ANTI-ICE AS RQRD
 ECAM STATUS CHECKED
 TRIM % SET, ZERO

BEFORE TAKEOFF

FLIGHT CONTROLS CHECKED | BOTH
 FLAPS | BOTH



Standards and Recommended Practices

- Observed** line cabin operations (focus: OM published in designated common language).
- Other Actions** (Specify)

CAB 1.6.7

If the Operator publishes a practical manual for use by the cabin crew in the performance of cabin operations duties, the Operator shall ensure one or more copies of the up-to-date practical manual are on board the aircraft for passenger flights and located in a manner that provides for immediate access by each cabin crew member. **(GM)**

Auditor Actions

- Identified/Assessed** onboard availability/access of practical manual to cabin crew members.
- Interviewed** cabin operations manager/designated management representative(s).
- Examined** practical manual used by cabin crew members.
- Observed** line cabin operations (if applicable) (focus: one or more copies of up-to-date practical manual on board; cabin crew has immediate access to practical manual).
- Other Actions** (Specify)

Guidance

Refer to the IRM for the definition of [Practical Manual](#).

A practical manual (or QRH, QRM) is a condensed version of the OM designed for use by personnel in conducting frontline operations. It contains selected reference information, policies, procedures, illustrations, memory aids, checklists and/or other material necessary from the OM to ensure standardization in performing normal duties and addressing non-normal, abnormal and/or emergency situations.

A practical manual is typically required to be in the possession of each individual cabin crew member in electronic or printed format, or available at each cabin crew station or other location that ensures immediate access by each cabin crew member.



AFTER BOARDING

INFANT LIFE VESTS /EXTENSION BELTS.....	DISTRIBUTE	CA
SCPs/SAFETY ASSISTANT SEATING.....	VERIFY	ALL
OVERWING EMERGENCY EXIT OCCUPANCY	VERIFY	CA 4R
OVERWING EMERGENCY EXIT ROW PAX SAFETY BRIEFING	PERFORM	CA 4R
OVERWING BRIEFING TO SCCM	REPORT	CA 4R
CABIN PREPARATION.....	COMPLETE	CA
DOOR CLOSING PROCEDURE.....	PERFORM	ALL
DOOR ARMING PROCEDURE.....	PERFORM	ALL

NORMAL

TAXI-OUT

ANNOUNCEMENT " <i>CHIUSURA PORTE</i> ".....	PERFORM	CA
PRE-TAKEOFF PASSENGER SAFETY BRIEFING	PERFORM	ALL







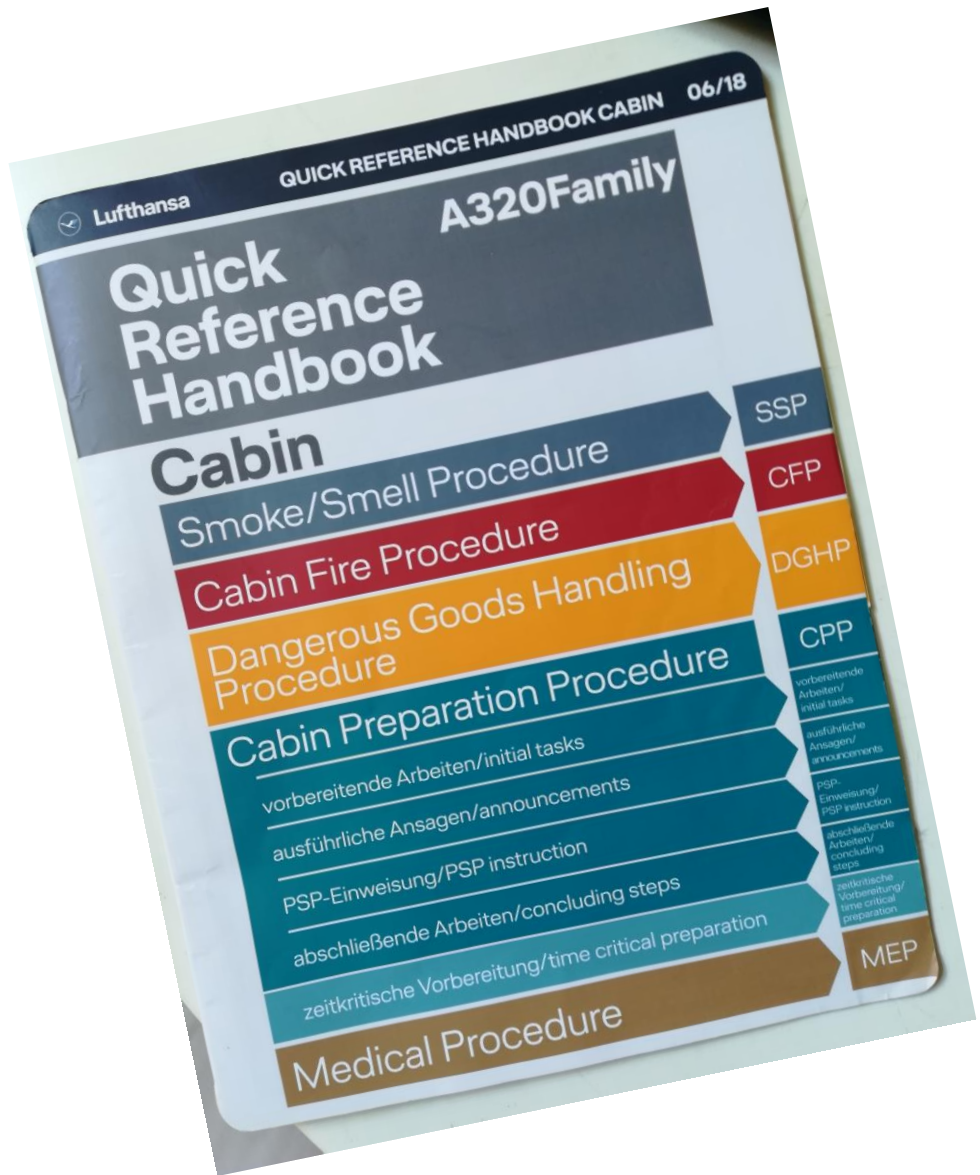

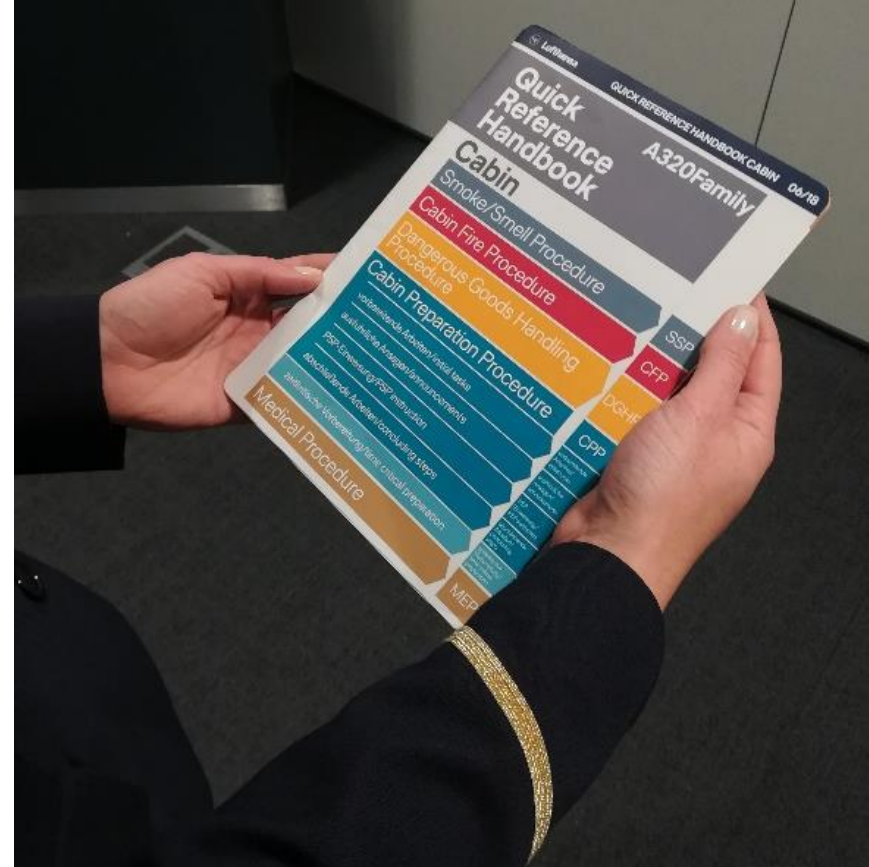

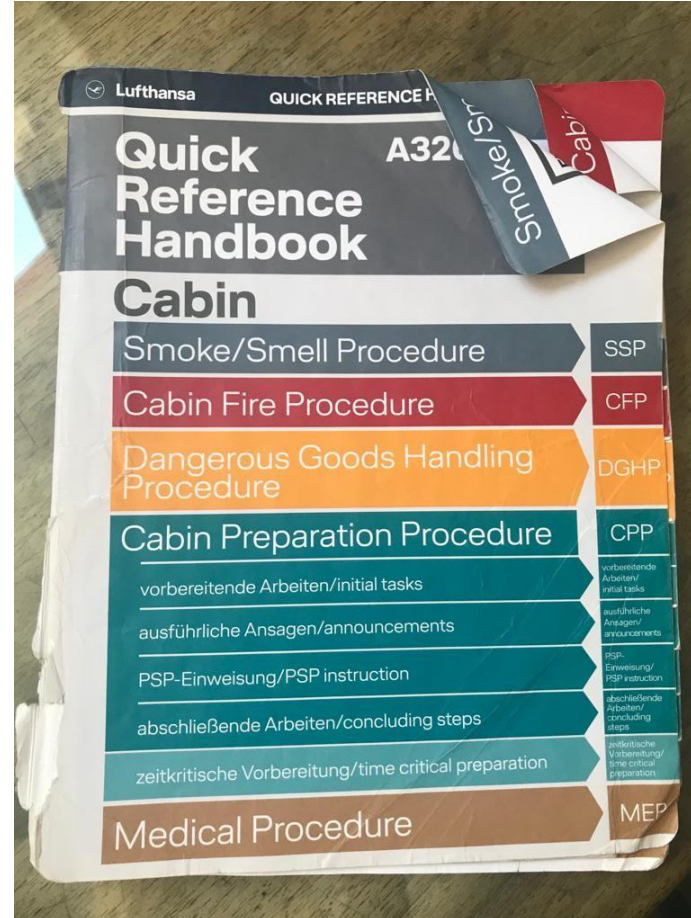



Everyone should have one

Join the benchmark?

Ideas?

Questions?

julia.arnds.cf@dlh.de

CABIN INNOVATIONS INJURY REDUCTION AND PREVENTION

June 2022

Edwin Fernandez

**Manager, In-Flight Service (IFS) Cabin Safety,
Analysis and Technology**





Cabin Crew Injuries

A look at Cabin Crew Injury Drivers.



Product Offerings

Current Cabin Furnishings and Equipment Offerings and Options to Mitigate Injuries



Cabin Innovations

Cabin Furnishings and Equipment Concepts and Designs



Policies and Procedures

Application of Policies and Procedures to Mitigate Injuries



Training, Visual Aids and Injury Prevention Initiatives

Resources Available for Injury Awareness and Injury Prevention.



Technology

Resources Available for Injury Prevention and Injury Reporting.



Cooperation, Collaboration and Partnerships

Across the industry including Worldwide Airlines, Aircraft Manufacturers and Suppliers of Aircraft Furnishings and Equipment.

Galley Evolution





Cabin Crew Injuries

What is Wrong with these Pictures?



- Boeing 767-300ER Aft Galley Turbulence Event.

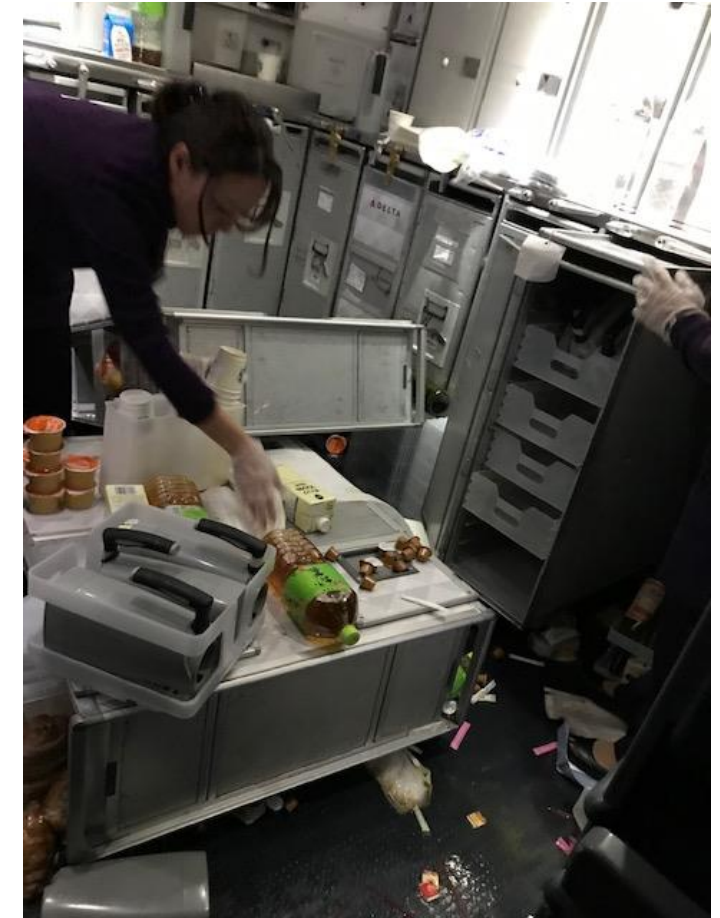

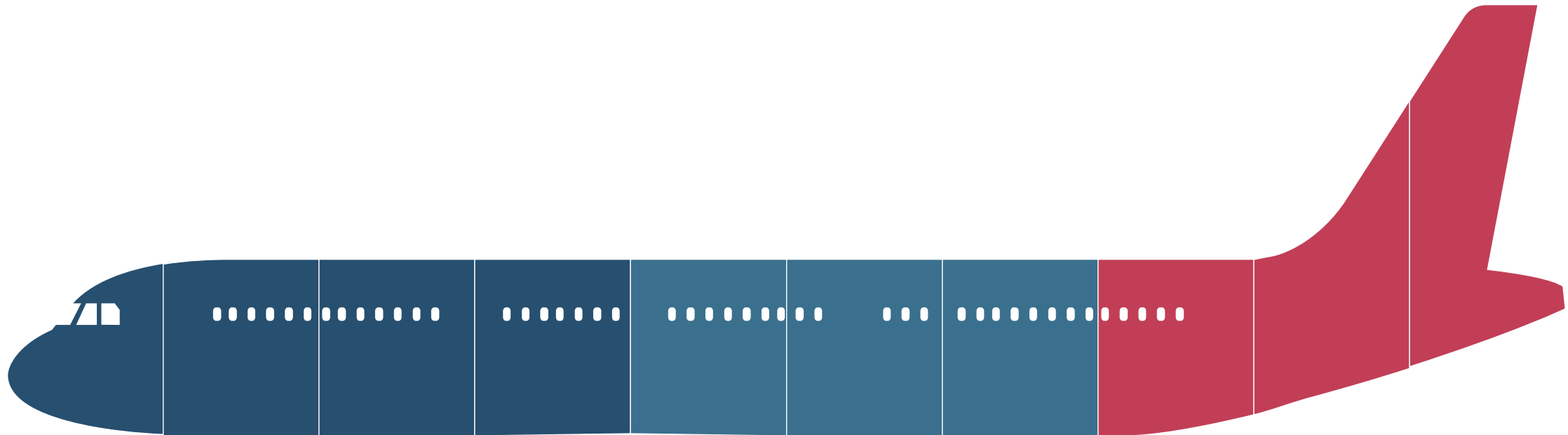

24.6%

Ergonomics

- Carry-on bags re-arrangement
- Closing bins
- Carts and Carriers – Pull/Push

14.4%

Turbulence

- Un-anticipated
- Insufficient number of CAS

13.9%

Struck By/Against

- Situational Awareness
- Reaching under counter – Head strike
- Cart strike
- Sanitizer Stations

Major Injury Categories per 1M Block Hour (BH)s by Year



- On aircraft injury categories appear according to highest overall rates since 2018.
- On the Job Injury (OJI) rates dropped substantially in 2020 due to fewer Cabin Crews flying fewer Block Hours (BH).
- Some categories remain lower in 2022 versus their pre-pandemic rates: Ergonomic, Turbulence, On Aircraft Slips/Trips/Falls and Aircraft Movement.
- Struck By Against, Pax Action and Pivot have grown since the pandemic's onset.- unruly passengers and lack of familiarity with surroundings and equipment may be the causes.

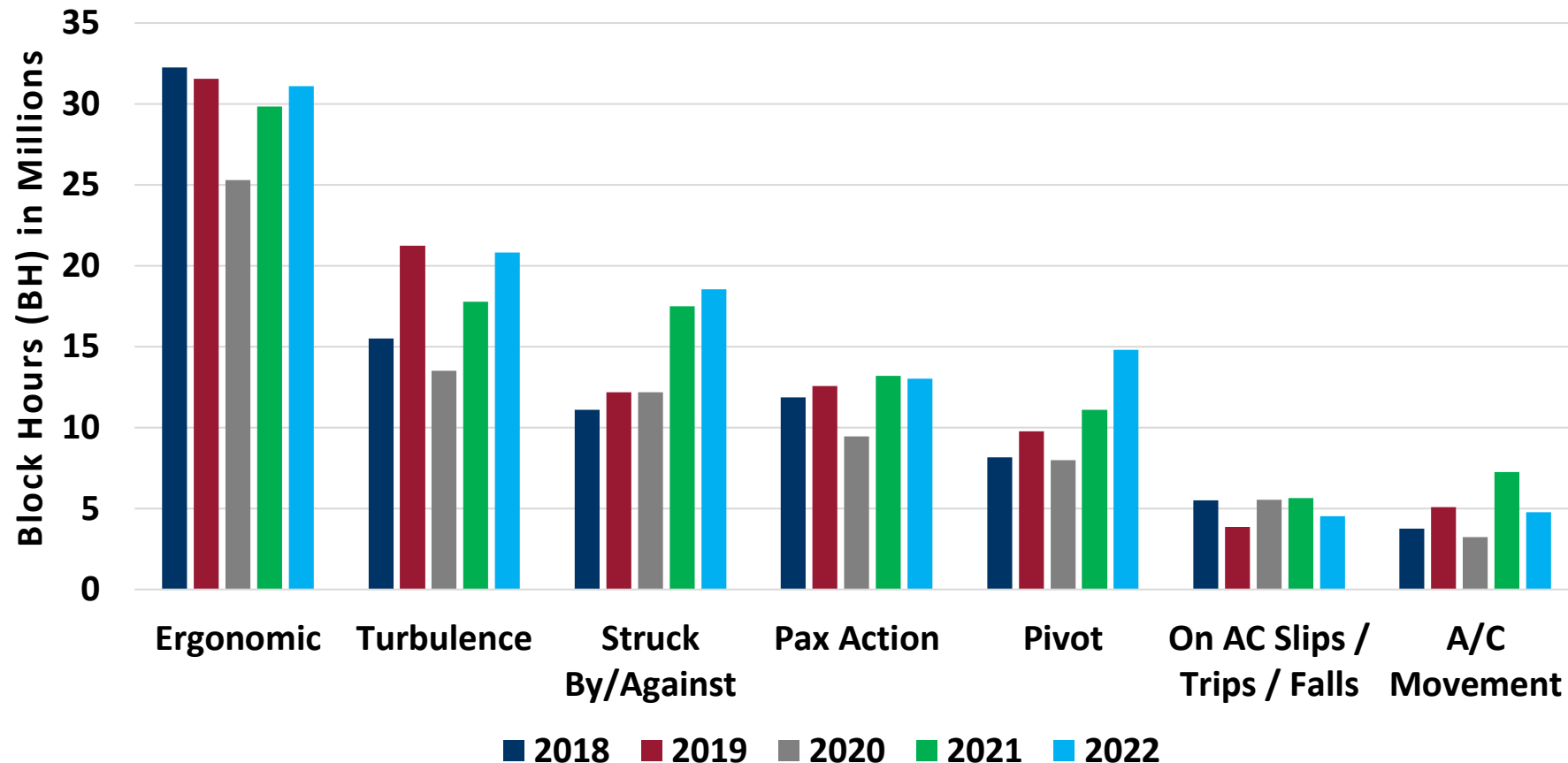

Turbulence OJI Rates per 1M BHs by Number of Aft CAS



- Rates according to the total number of Cabin Attendant Seat (CAS) installed in the aft section of an aircraft since 1 March 2021.
- The more CAS in the aft; the lower the OJI Rate.
- Rate reduced by roughly 50% by adding a single CAS in the aft section of an aircraft.

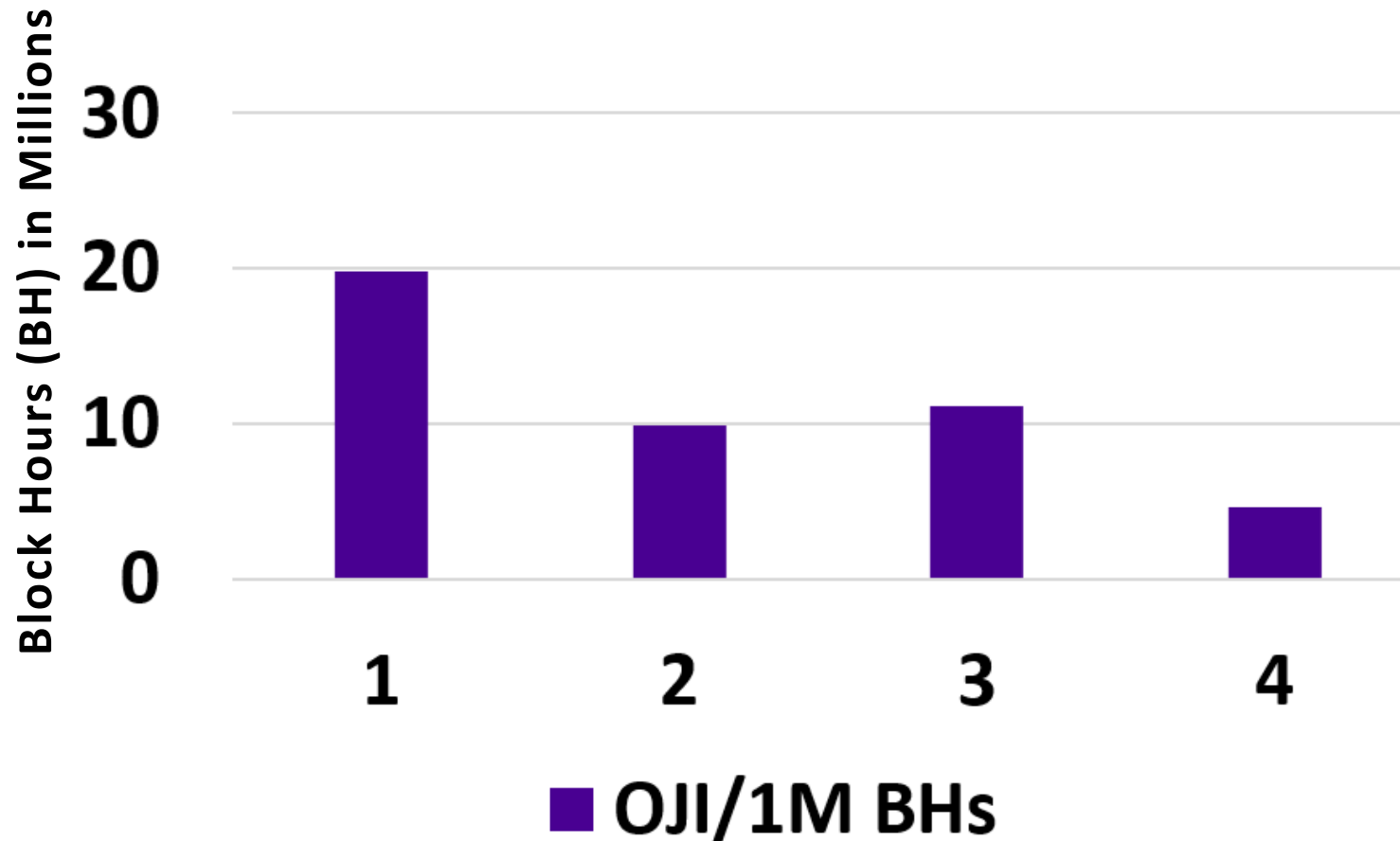



Product Offerings

Cabin Attendant Seat (CAS)



- 4 to 6 CAS recommended in aft galleys aligned to the number of Cabin Crew working the main cabin of the aircraft.

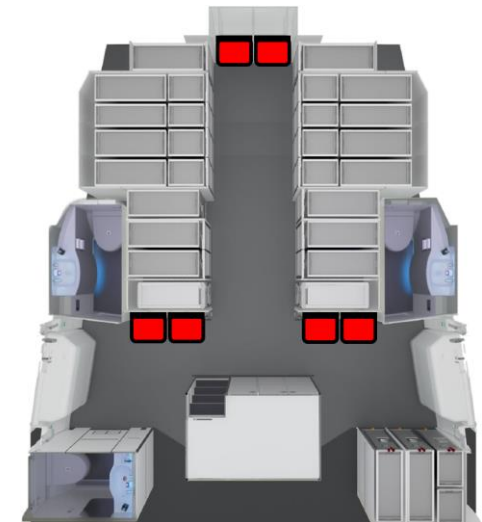

Cart Straps



- Recommend making cart restraints a requirement flow down to aircraft manufacturers and suppliers of cabin furnishings and equipment, including galley manufacturers.

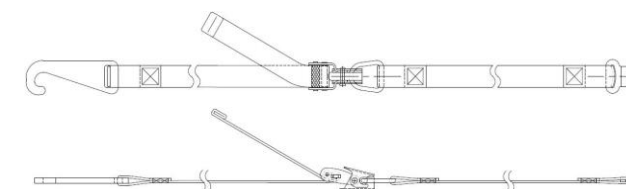
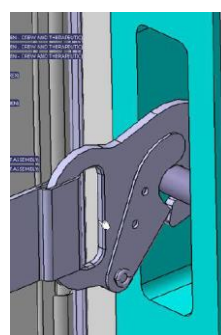
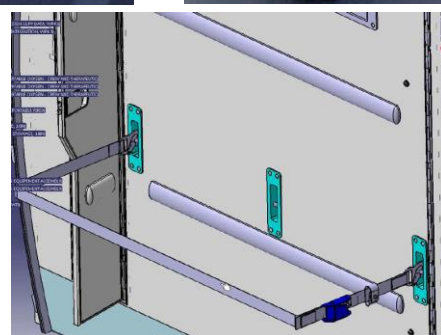
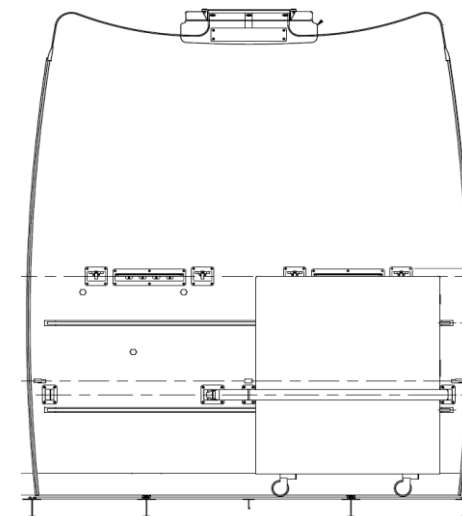
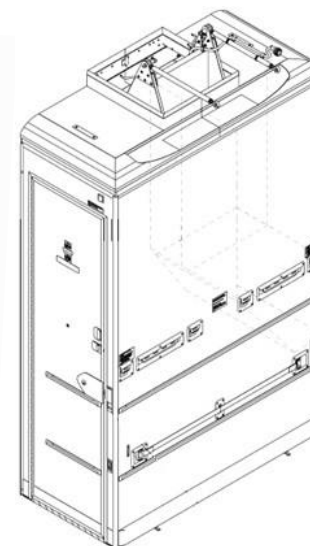
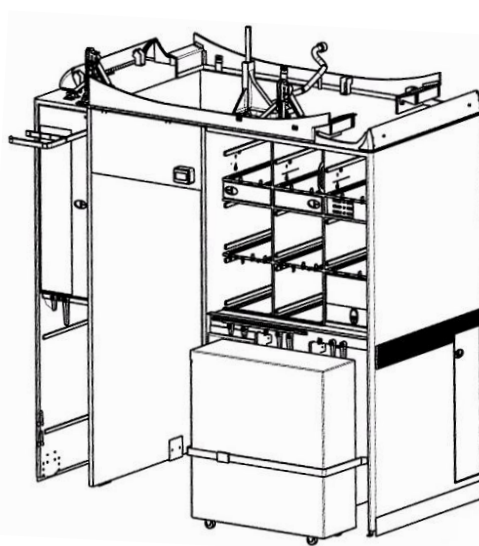

Minor Changes to Prevent Injuries



- Padded head protection.
- Red latches on carts and carriers.
- Spring loaded golden latches on cart bays facing an aisle.

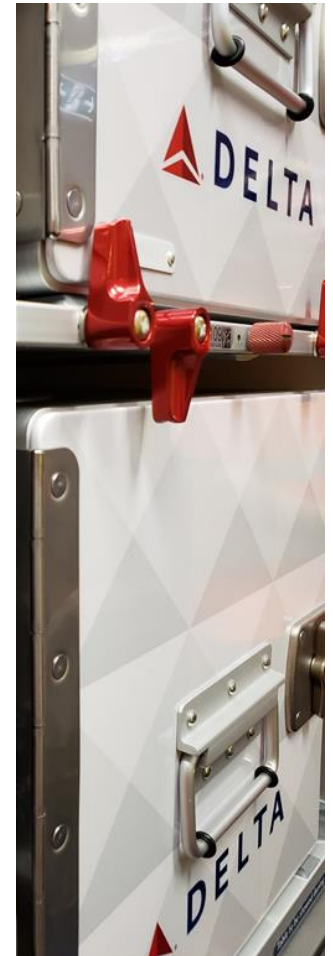

Hand Holds, Grab Handles and Grab Bars



- Provides Cabin Crew with an engineered and tested solution to secure and stabilize themselves; particularly, during turbulence conditions; more so when a CAS is not available to sit on.

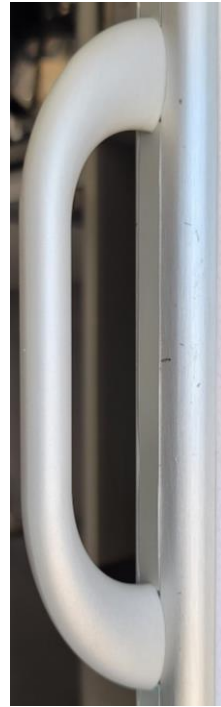

Crew Rest Facilities

- Installation of retractable footsteps and grab handles to facilitate ingress and egress into upper bunks in crew rest facilities onboard the aircraft.

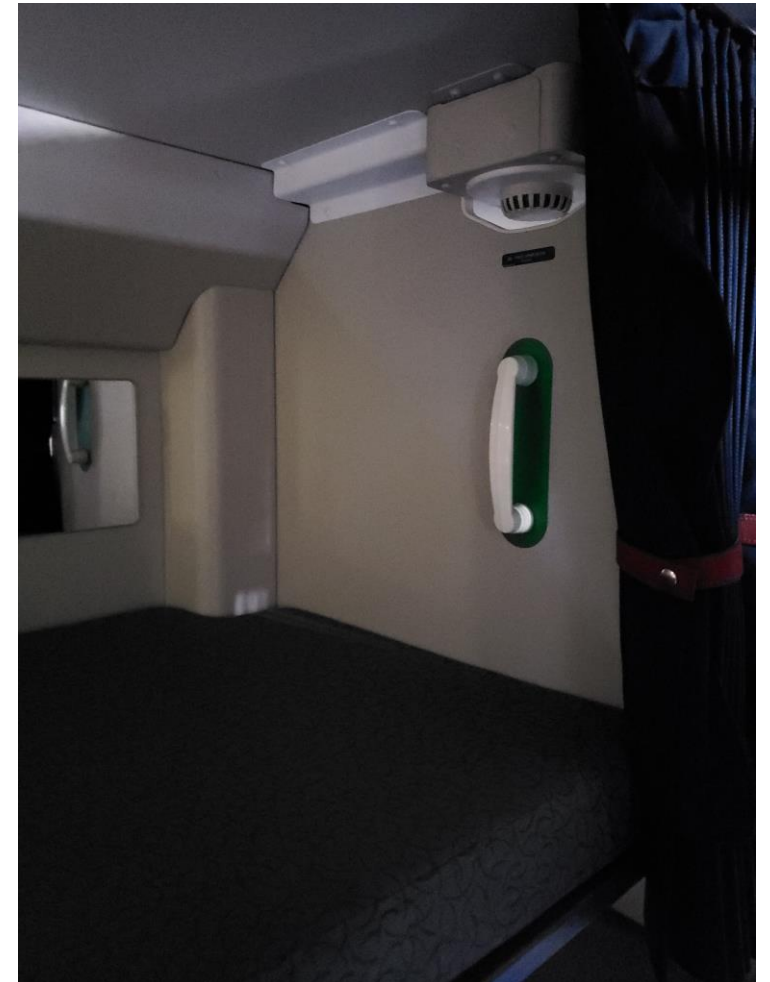
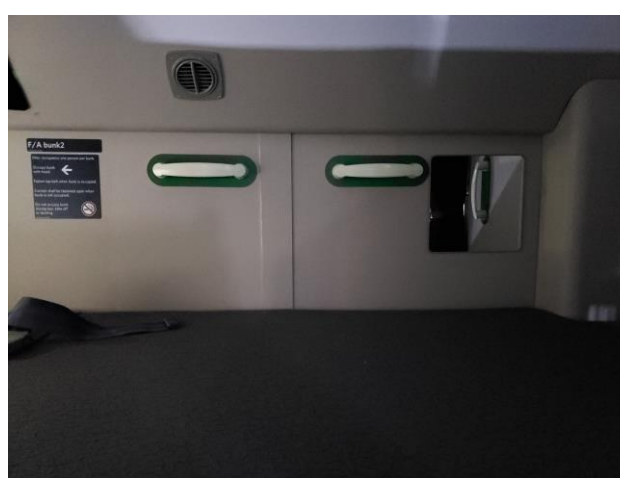



Cabin Innovations

Certification, Regulations, Standards and Policies



International Civil Aviation Organization (ICAO) Standards and Recommended Practices (SARPs)



Federal Aviation Administration (FAA)

European Aviation Safety Agency

Transport Canada Civil Aviation

Other Country Specific Regulatory Agencies

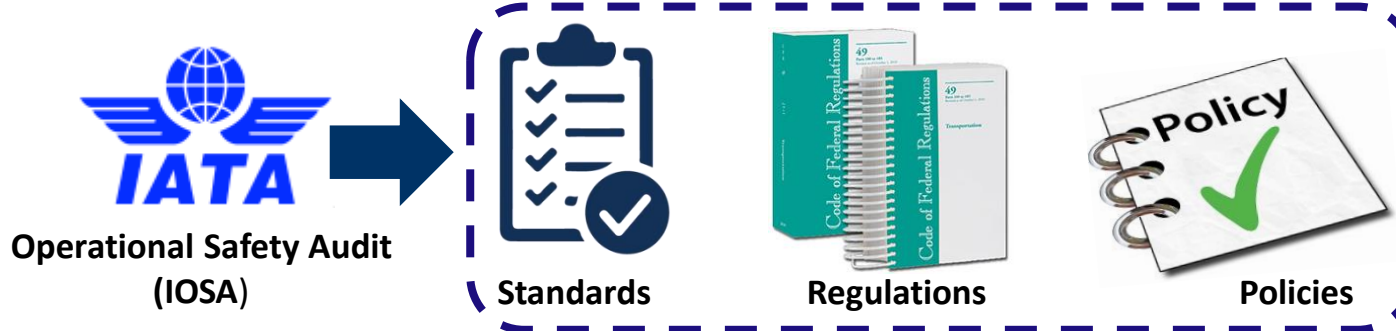

Operator/Airline

Boeing 767-300ER Slide Out Cabin Attendant Seat (CAS)s



- Slide out jumpseat installed on the forward partition of the aft lavs on the B767-300ER aircrafts shown.
- Certified for Taxi, Takeoff and Landing (TTL).

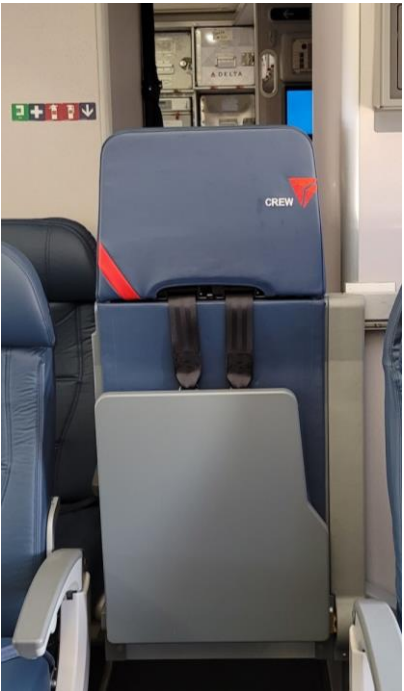

Lift Assist Unit (LAU) and Bin Lift Assist (BLA)



- Bin Lift Assist (BLA) solutions with electro-mechanical Lift Assist Unit (LAU) typically rely on a Gas spring or dynamic damper on the opposite side of the bin to reduce the force required to close the bin.
- A load sensor will measure the baggage load in the bin when the bin is in open position. When a predetermined load threshold has been reached, the actuator will be released by an actuated latch mechanism.
- The actuator provides a force that will assist in closing the bin.
- The Lift Assist Unit (LAU) reduces the closing force of the bin by storing energy in a spring during the opening process of the loaded bin. It measures the load status of the bin and activates the support if needed.

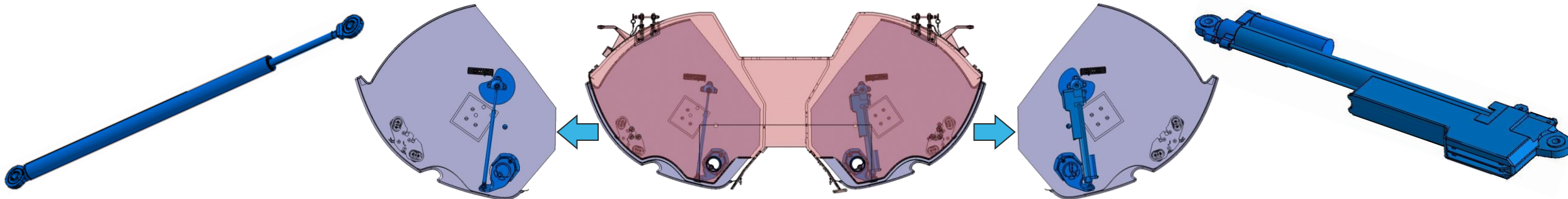
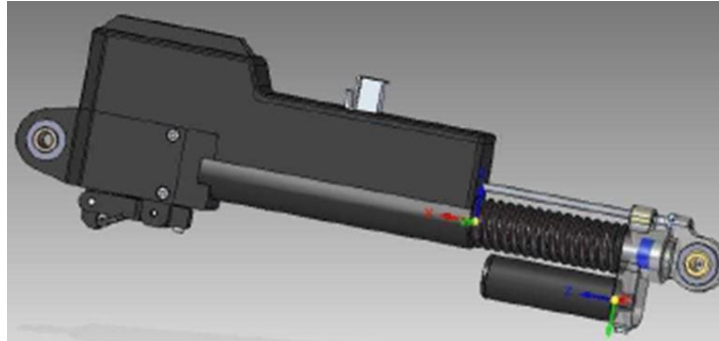
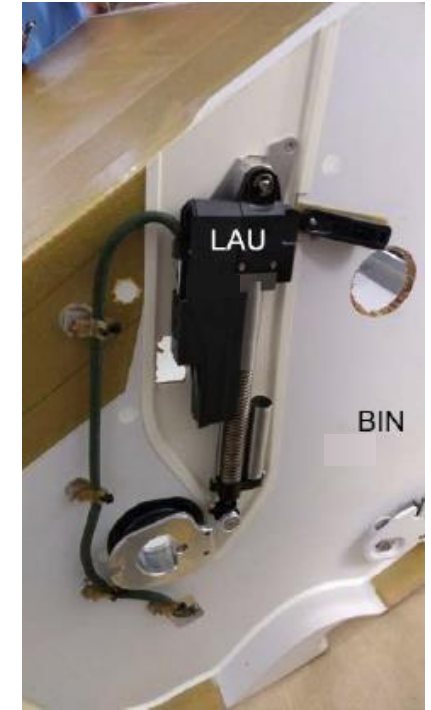

Service Cart Kick Stand



- Provides stability to prevent service cart from tipping over.
- Concept study conducted by Georgia Institute of Technology (GA Tech) and sponsored by Delta.

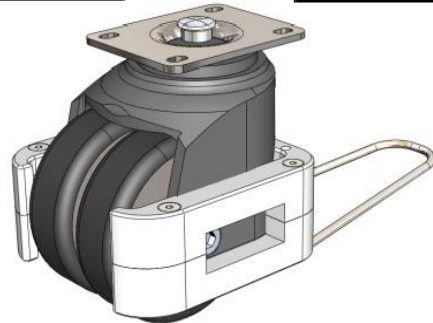

Atlas Box Slide with Riser and Galley Folding Step



Atlas Box Slide with Riser

- Allows Flight Attendants to bring a second or third depth Atlas carrier to the front and then lift down
- Atlas carriers glide along a low friction track and then lower for ergonomic removal
- Available on new HAECO Cabin Solutions monuments
- Possible to retrofit depending on customer requirements

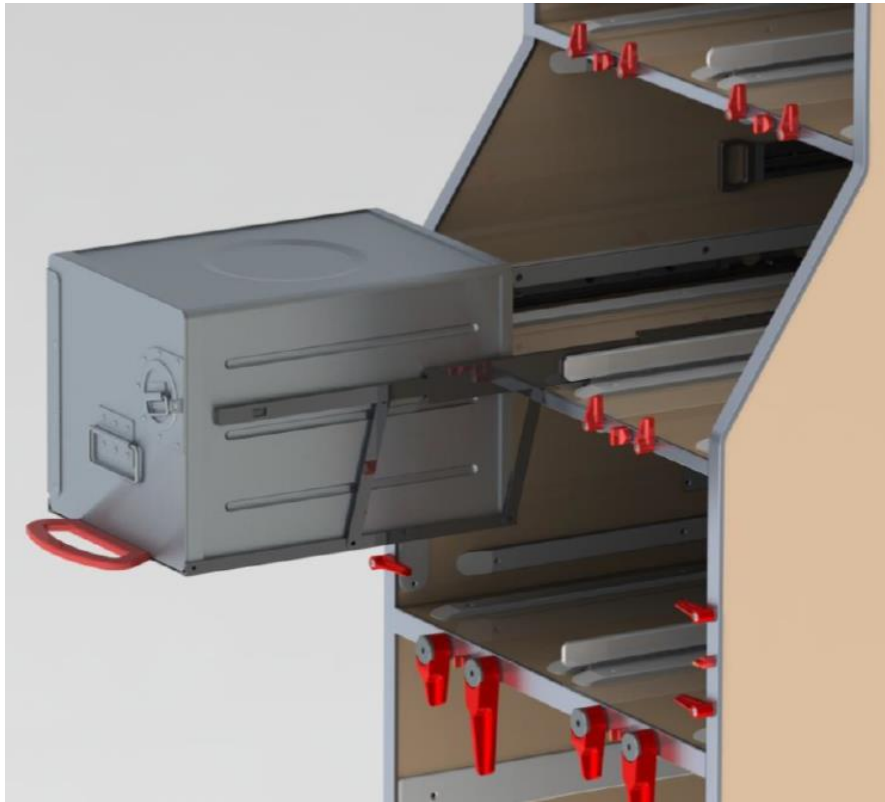

Folding Step

- Stow-away galley attendant step allows access to hard-to-reach areas with a simple retrofittable device.
- Engineered with safety catches and non-slip surfaces minimize hazards
- Can also be installed with complementary hand hold
- Designed with lightweight, high strength materials to reduce space requirements and maintain functionality



Note: System Description and Technical Information provided by HAECO Cabin Solutions, LLC.



Policies and Procedures

CREW USE ONLY Headrest Covers



- Mitigates turbulence related injuries due to insufficient number of Cabin Attendant Seat (CAS) in the aft galley of an aircraft.
- First deployed on the Boeing 767-300ER and available on A321CEO, A330-200 and A350.

Cabin Crew On Board Manual (OBM)

- Turbulence Safety Seats: Seats which have been “Z” blocked for FA use in event of unexpected moderate or greater turbulence while working in aft galley area. These seats will remain open if the flight is not completely full and will be the last seats ACS will assign on the aircraft.
- They are not available to non-revs and FAs should not move customers and/or CAS riders into these seats. Carry-on baggage may not be stowed at/on the safety seats.



Aircraft	Configuration	Seat(s)	
		Row	Identification
A321-200	321	39	BC
A330-200	332	35	H
A330-200	3M2	51	H
A350-941	359	55	EF

Aircraft	Configuration	Seat(s)	
		Row	Identification
B767-300ER	76L/Z	41	FG
B767-400	76D	45	FG
B767-400	764	56	FG



New shorter pilot commands will provide quicker, clearer and more concise direction for flight attendants and be delivered before the lengthy customer Public Announcement (PA).

- **Unexpected moderate turbulence pilot PA:** *"Flight attendants, take your jumpseats, for your safety."*
- **Unexpected severe turbulence pilot PA:** *"Flight attendants, be seated immediately, for your safety."*
- **Expected turbulence:** Now pilots will place an interphone call to brief the Purser/Flight leader and crew and then do the customer service PA.
- Additionally, pilots will use a **new command once turbulence has cleared** *"Flight attendants, check in"* will be the standard signal (given by PA) following any moderate or greater turbulence event to flight attendants that it is safe to get up, check for any injuries (crew and customer) as well as cabin conditions, then report that information to the Purser/FL who will report to the Captain. It is critical that anytime a crew member is injured due to turbulence, that the Captain be informed so he/she can send down the PINJ code to alert the OCC.



- In a comprehensive effort to reduce flight attendant injuries, the In-Flight Service (IFS) Health, Safety, Security and Wellness (HSSW) Team has taken a data driven approach to injury reduction.
- One area of improvement was found in Cabin Crew turbulence related injuries that occur during the descent (initial and final) phase of flight.
- This complete phase accounts for 40% of turbulence related injuries.
- Furthermore, 22% of turbulence related injuries occur only on the final descent phase of flight.
- The initiative outline is a cross divisional collaboration to safeguard Cabin Crew and ensure they accomplish all necessary safety functions and be seated at their CAS sooner with no impact to current service standards.
- After conducting 3 separate tests, IFS HSSW, Flight Operations (FOPS) and the Employee Involvement Group (EIG) have agreed to review and discuss the implementation of procedures.
- IFS predicts a new safety initiative could result in a 20%-30% reduction in turbulence related injuries.

Objective

- Create a new descent procedure that allows flight attendants to be seated sooner
- Work cross divisionally to lower flight attendant injuries due to turbulence
- Create a communication strategy that includes all relevant parties and educates flight attendants on new procedures
- Monitor/measurement of success using data



“When packing, please remember that flight attendants are unable to proactively assist customers placing carry-on baggage into overhead bins, with certain exceptions. In addition to keeping customers and crew members safe and healthy, this change also protects flight attendants by decreasing the likelihood of injury caused by repetitive lifting.”



 **Training, Visual Aids and Injury Prevention Initiatives**

Service Carts



- Service carts, when not properly managed, have the potential for causing injury to cabin crew and customers.
- Injury data shows that the largest percentage of cart injuries were occurring on B-767 aircraft.
- Cart injuries can occur at any time on any aircraft if proper care is not taken.
- The safe operation of service carts requires adherence to procedures designed to ensure proper stability, weight and handling.

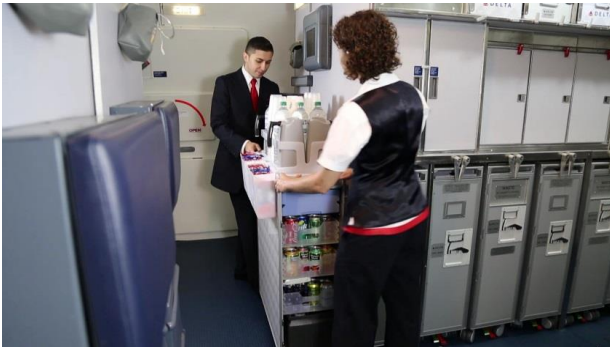
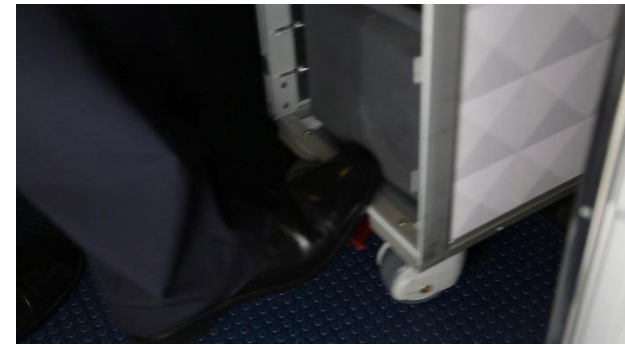

Airbus A350 Overhead Bins



- Airbus A350 overhead pivot bins training video is offered to all Cabin Crew to explain and demonstrate proper Ergonomics and Body Mechanics Techniques to be applied when closing the overhead bins to prevent injuries.



Near Field Communication (NFC) Posters



- To promote and raise awareness to reduce and prevent injuries, posters with Near Field Communication (NFC) tags are available at Cabin Crew bases systemwide.
- These posters provide ergonomics and body mechanics guidance and information. The NFC tags on the posters provide the mechanism to view and download videos to the SkyPro.



Pristine Condition

- Ergonomics and Body Mechanics techniques training to teach cabin crews ways to better move around the aircraft cabin while safely performing physical tasks and activities in the cabin crew's unique work environment with minimal risk of injury.





IFS LifeSavers

"I'VE GOT YOUR BACK"

Help Each Other

The hazard is the problem, not the person. Be respectful and kind when sharing your knowledge and work together.

Safety Knows No Seniority

Be open to receive safety advice regardless of seniority.

Have the **courage** to communicate safety advice regardless of seniority.

Safety is Service

Do not let the task at hand overtake the need to complete it safely.

Silence is Acceptance

Speak up and take action if you see something unsafe.

Injury Does Not Discriminate

Don't fall into complacency. Let your colleagues know that 'it won't happen to me' is exactly why it will.

#IGYB

IFS LIFESAVERS



FASTEN INTO JUMPSEAT

During Taxi, Takeoff and Landing (unless performing safety-related duties)



ADHERE TO FLIGHT DECK DIRECTION AND PRACTICE SITUATIONAL AWARENESS

During Turbulence



SECURE THE GALLEY

Ensure galley latches are secure and cart brakes are engaged when not in use. (Also - remember never to overload carts/make them top-heavy for service delivery.)



HOLD ON

Use rails, hand and footholds to avoid falls



NEVER EXIT ONTO SERVICE TRUCK PLATFORM

#IGYB

I'VE GOT YOUR BACK

MISSION:

To strengthen our safety culture; where we are committed, empowered and engaged to keep ourselves and each other safe, so we return home from work in the same or better condition.

WHAT IS #IGYB?

- OUR PERSONAL SAFETY - FLIGHT ATTENDANT TO FLIGHT ATTENDANT
- Caring for and preventing each other from getting hurt
- Challenging the hazards/risk, not the person

WHAT #IGYB IS NOT:

It's not about writing each other up. By the time something is reported or a photo is taken to document the situation, the opportunity to prevent a potential hazard or injury has been lost.

If you can prevent an injury from happening - **WHY WOULDN'T YOU?** Remember...

SILENCE IS ACCEPTANCE. SAFETY KNOWS NO SENIORITY. SAFETY IS SERVICE.

brought to you by
EIG • HSS
#IGYB

IFS LIFESAVERS



FASTEN INTO JUMPSEAT

During Taxi, Takeoff and Landing (unless performing safety-related duties)



ADHERE TO FLIGHT DECK DIRECTION AND PRACTICE SITUATIONAL AWARENESS

During Turbulence



SECURE THE GALLEY

Ensure galley latches are secure and cart brakes are engaged when not in use. (Also - remember never to overload carts/make them top-heavy for service delivery.)



HOLD ON

Use rails, hand and footholds to avoid falls



NEVER EXIT ONTO SERVICE TRUCK PLATFORM



LIVESAFE
AT WORK | AT HOME | AT PLAY

I've Got Your Back #IGYB



- Peer to Peer safety conversations to manage potential hazards and prevent injuries on board the aircraft.

DELTA

I've Got Your Back.

Will you have mine?

#IGYB

As flight attendants, we tend to concentrate so much on customer service that we can lose focus on our own safety.

WHY?

SOMETIMES IT'S JUST...

- Faster or easier to do something a different way
- More comfortable or convenient

SOMETIMES I...

- Think that I won't get hurt
- Need to save time
- Don't really think about what to do or how to do it right

In our world, there is risk associated with nearly every activity. Delta Flight Attendants know how best to help each other and are Delta proud enough to care. This is who we are and what "I've Got Your Back" is all about.

#IGYB is a flight attendant-to-flight attendant safety movement that can get us there. It's about helping each other and encouraging open conversations to manage hazards that can pop up on board.





Technology



- WidgetWX is a weather application that provides supplementary weather information in addition to the primary weather information provided by Delta Meteorology in the form of Turbulence Plots (TPs).
- This app is currently a real-time tool available for prompt decision-making. Weather data in this app is updated using automated turbulence reports called Eddy Dissipation Rate (EDR) communicated by other aircraft in the area. This is a real time data feed allowing pilots to make an informed decision.
- Relies on Eddy Dissipation Rate (EDR) technology/systems communicated by other aircraft in the area equipped with EDR. EDR is an objective, aircraft-independent, universal measure of turbulence based on the rate at which energy dissipates in the atmosphere. As such, it is a measure of the turbulent state of the atmosphere.
- EDR is not a requirement; not all aircrafts have the EDR system installed.
- Auto-TP Uplink supplements the graphical display provided by FWV and FWV+.
- Pilots receive automated Turbulence Plot (TP) forecasts via ACARS from Delta Meteorology. Previously, these updates were manually sent by dispatchers. Automated updates ensure more timely and accurate information is being sent to pilots to review and act on.
- Cockpit automation system. It monitors aircraft flight path for potential flight trajectory improvements including conflict resolution for weather hazards.

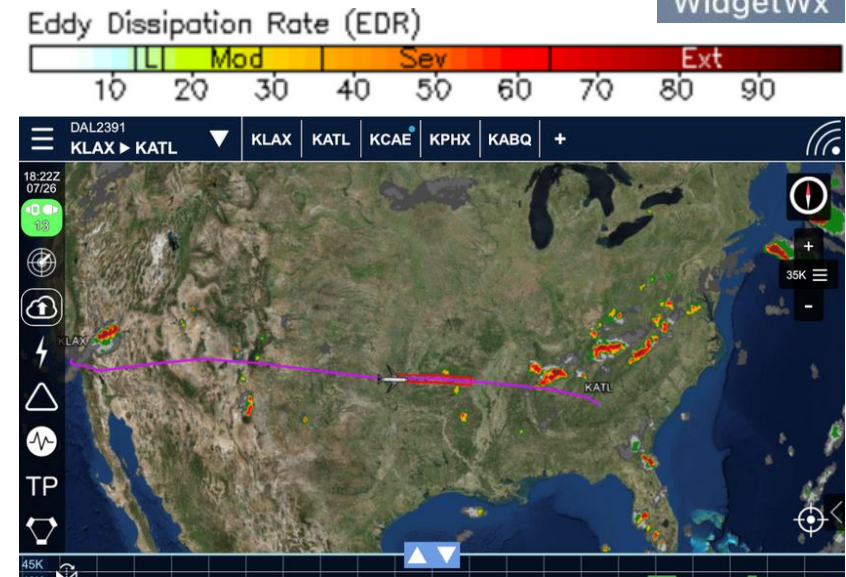

Safety Reporting App

- Turbulence Survey.

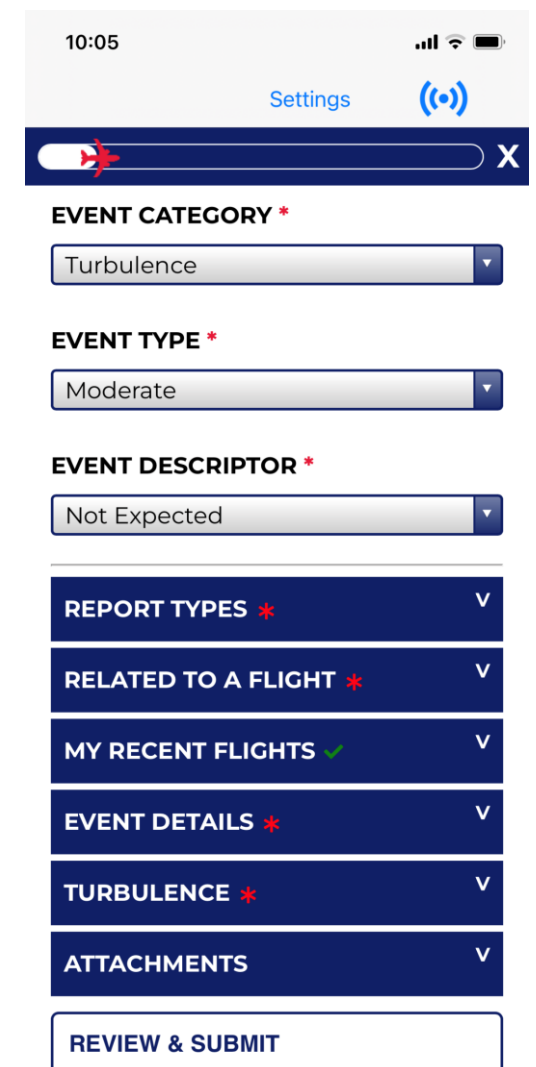
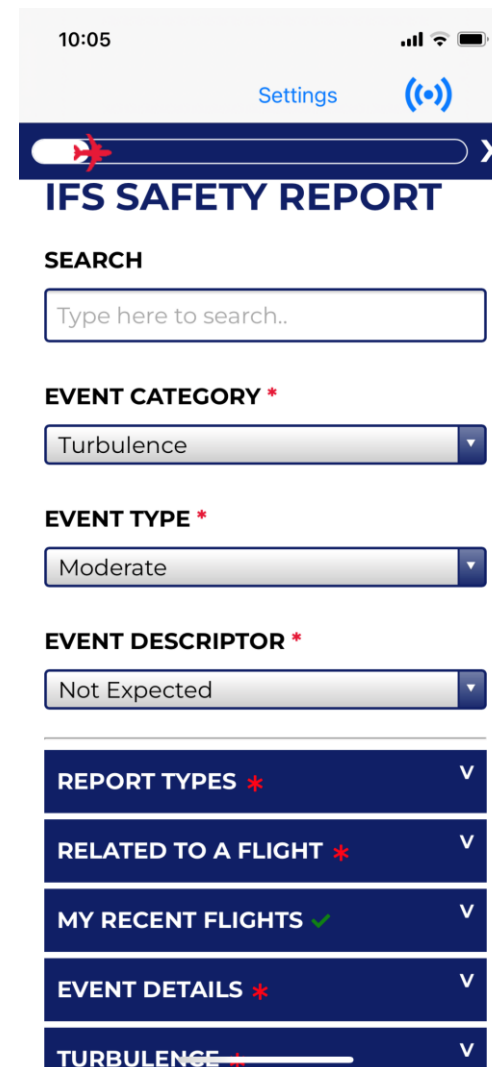
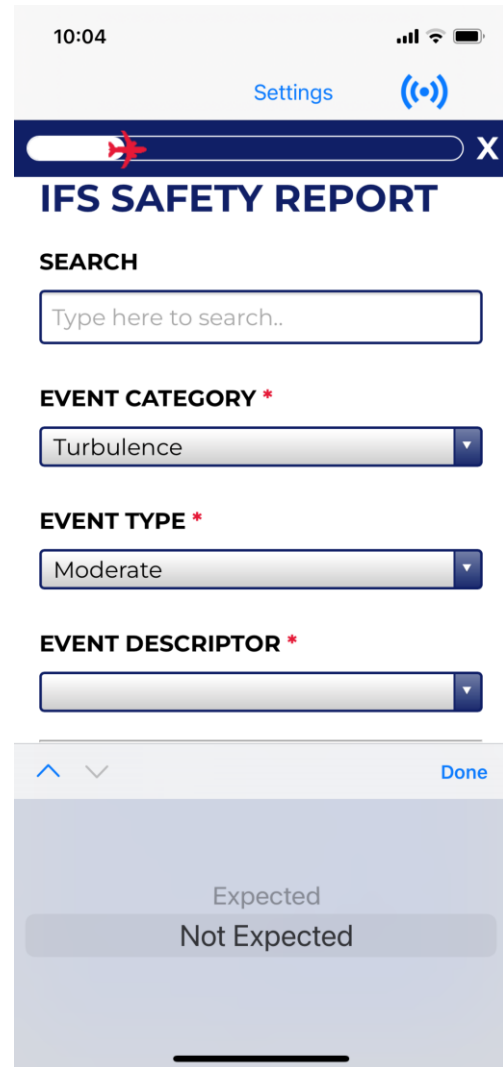
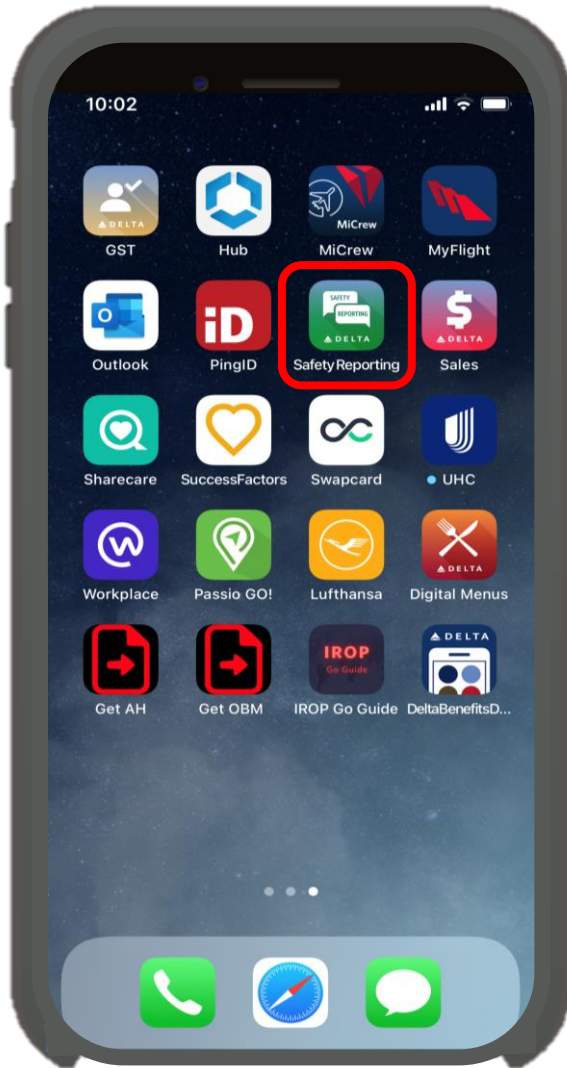



Cooperation, Collaboration and Partnerships

Typical Product Development Lifecycle Phases

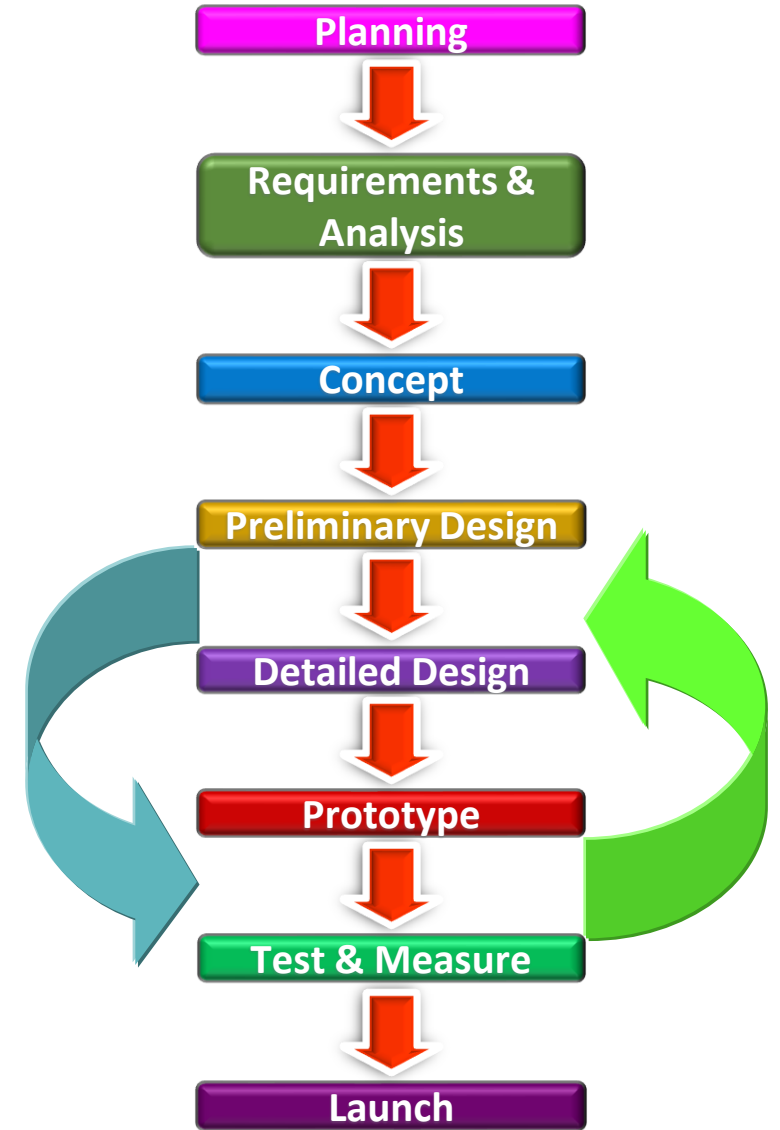

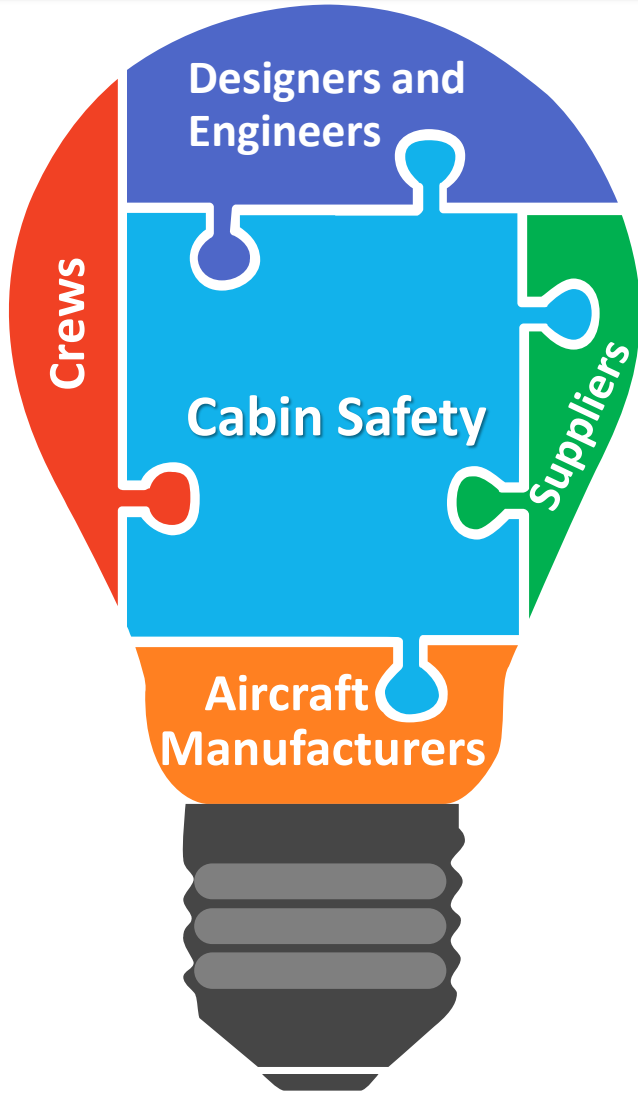

Brainstorming Together

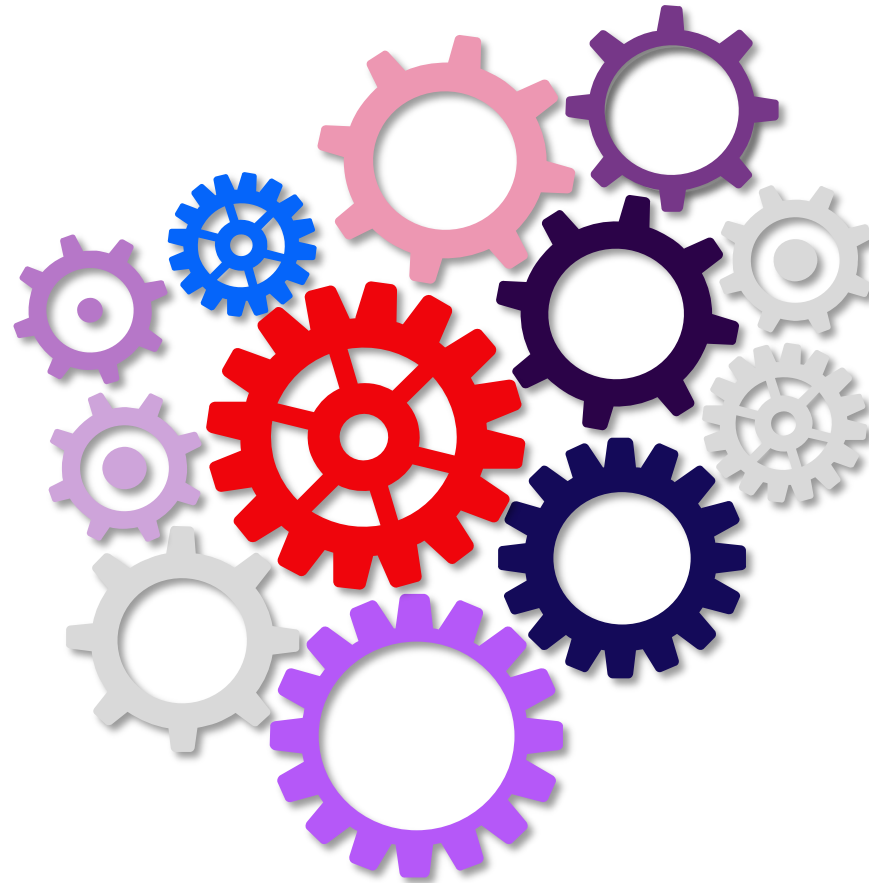

Engaging and Sharing Ideas

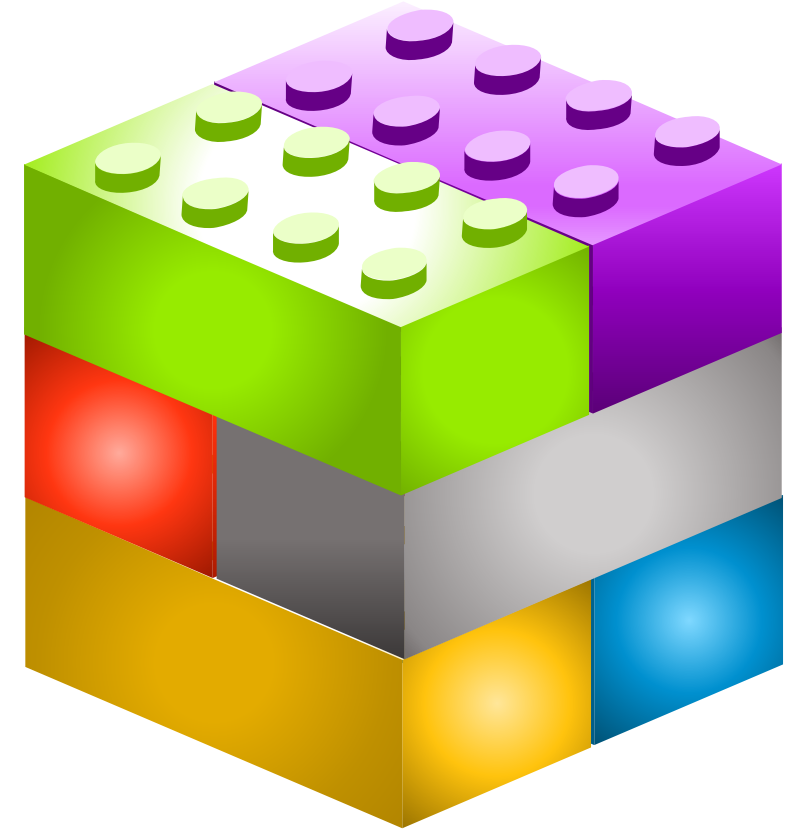

Building Solutions Together

Our Common Safety DNA

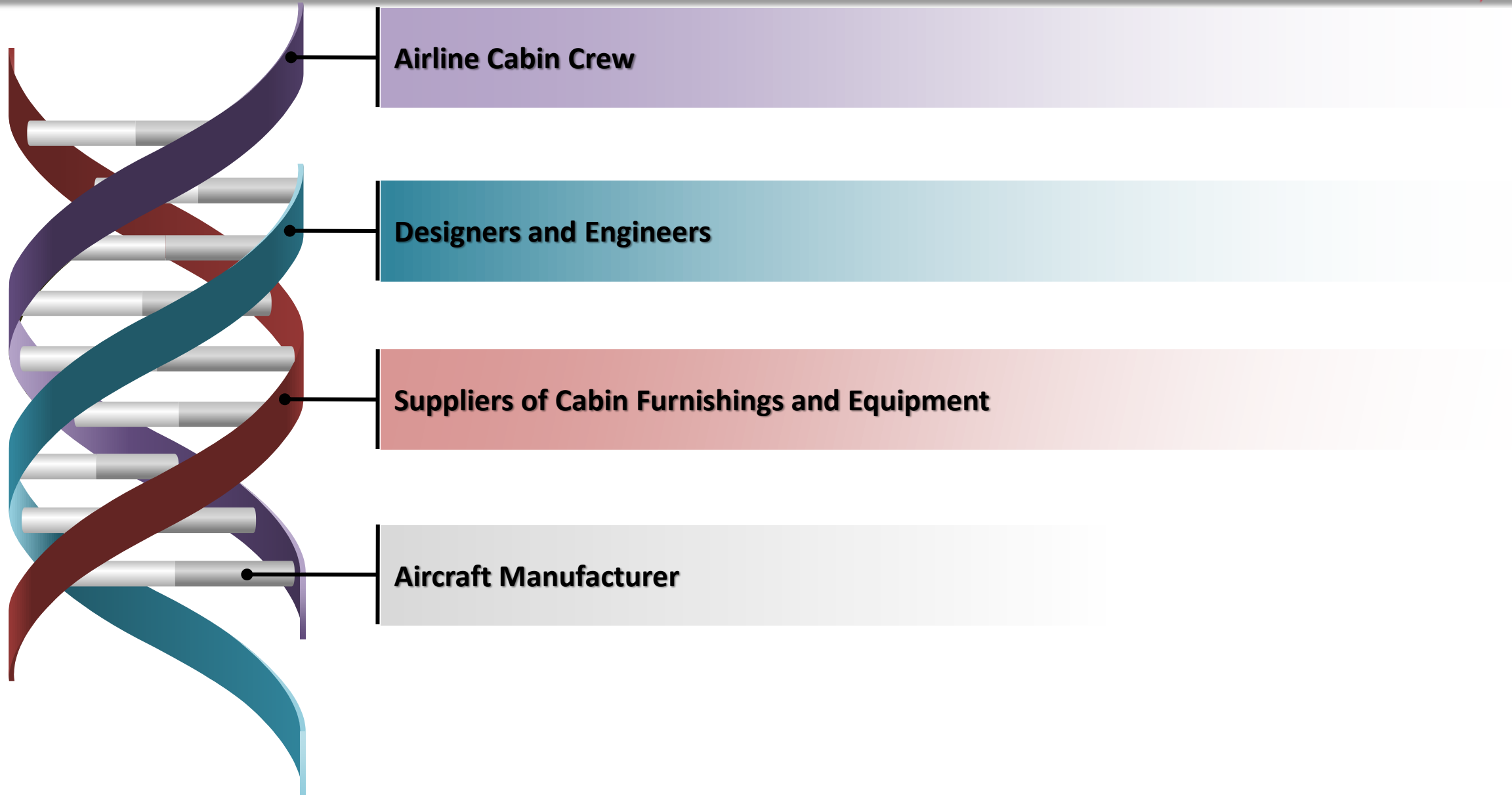



- Finding the right balance between cabin configurations/layouts including the design, selection and installation of cabin furnishings and equipment.

Hazard Elimination & Injury Prevention

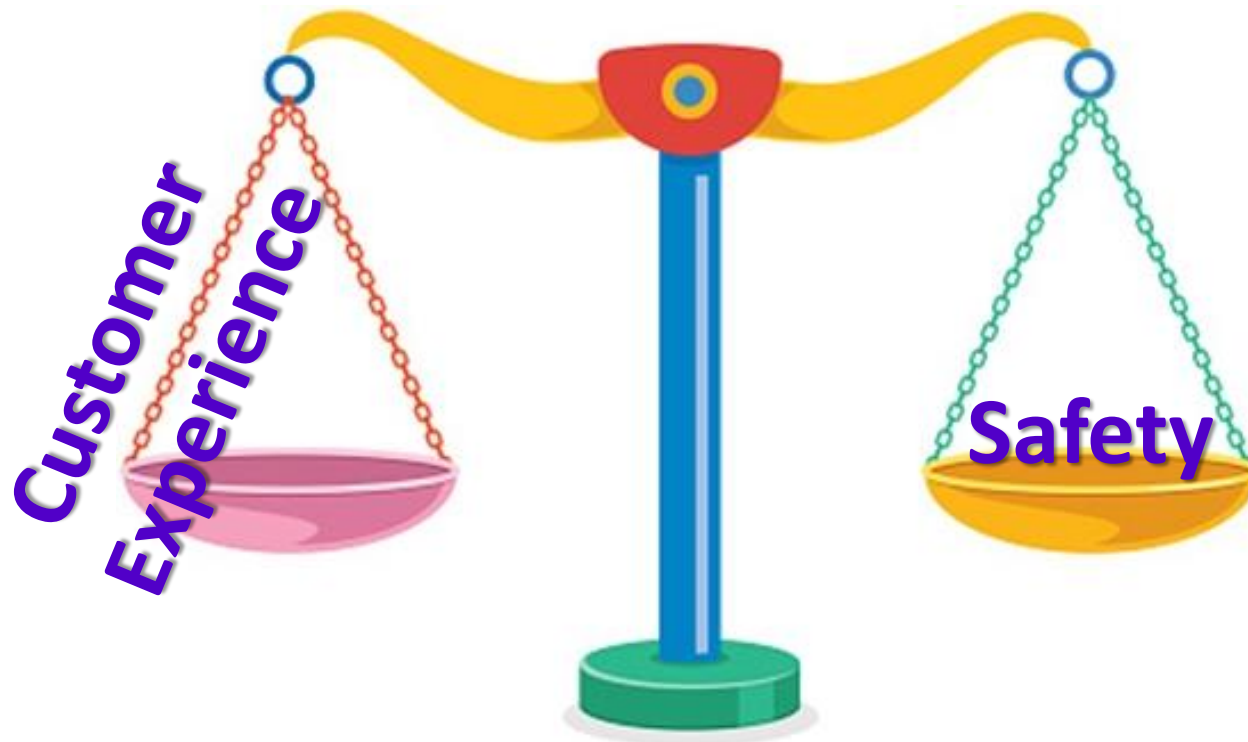



Where Do We Go from Here?



THANK YOU



DELTA



Accessible travelling
An onboard wheelchair
An accessible lavatory
On a narrow-body aircraft

Thesis by Antti Suopajarvi 7.5.2021

A Story

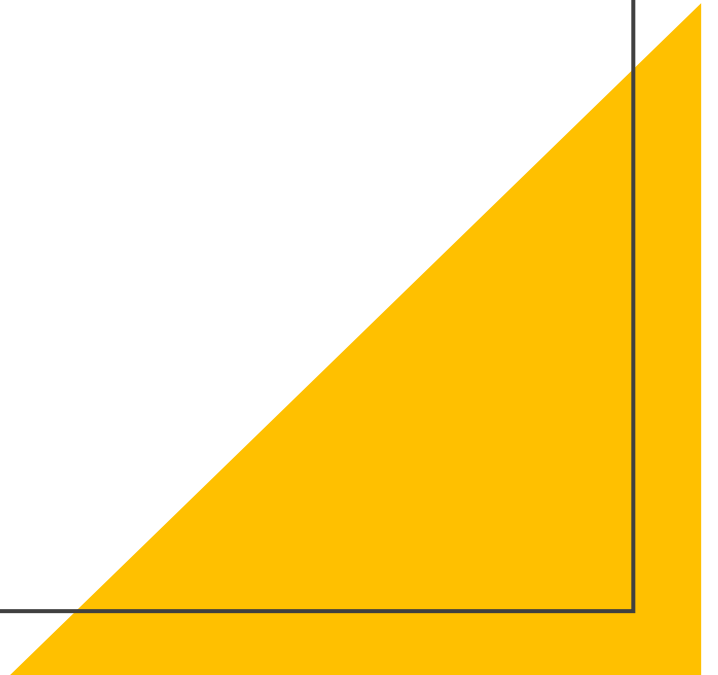

The research question

How can the airlines and aviation industry improve the accessibility for a PRM to use the narrow-body aircraft lavatory from the customer point of view?



Amount of PRMs

Demographic indicators show that by 2050 one-fifth of world's population will have disability or mobility issues

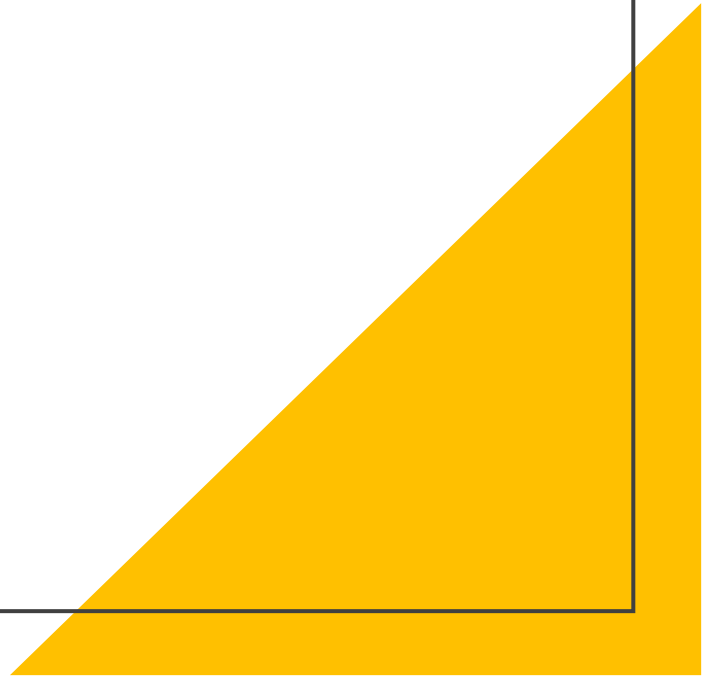

Regulative issues

- **DOT 14 CFR part 382**
 - Notice of Proposed Rulemaking "Accessible Lavatories on Single-Aisle Aircraft"
 - **European Union (EC) No 1107/2006**
 - Remains to be seen
- 
- A large yellow triangle is positioned in the bottom right corner of the slide, pointing towards the top right.

Disabled Lavatory Designs

Airbus Space-Flex – already in use

Collins Aerospace Company – Pax Plus

Acumen Lavatory – Expandable lavatory space



The Survey

118 respondents from Finland only

336 respondents via a global survey by Mr. Joshua Wintersgill (Ablemove UK)

Survey summary is available on my LinkedIn profile

Interviews with aircraft manufacturer and accessibility experts and bloggers



Narrow-body traffic survey facts



67,8% of PRMs would travel 1-7 times more per year, if aircraft was equipped with accessible lavatory and an onboard wheelchair



56,8% of PRMs did not find information about accessible lavatory or the existence of an onboard wheelchair before their flight



72% of PRMs think that they would choose a particular aircraft manufacturer's plane if the onboard wheelchair was available as per standard

Recommendations

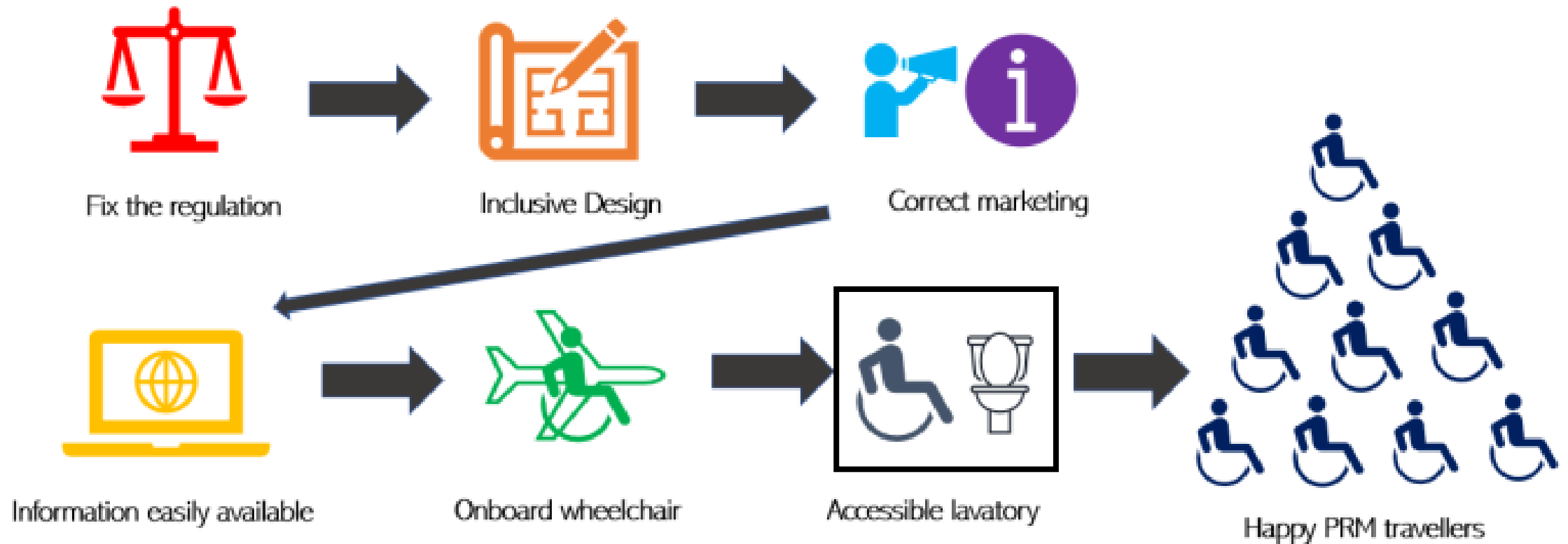

Training

Disabled airline traveler experience exposes lack of uniform training standards

Need for global harmonization of training standards and disability legislation



IATA

IATA has Global Accessibility Symposiums (IGAS) in 2019 and 2020.

These events have offered the public relevant information about the status quo in global accessibility issues

- IATA Passenger Accessibility Operations manual (IPAOM) Guidance for airlines to serve travelers with disabilities - 2021
- Transport of Battery-Powered Wheelchair and Mobility Aid Guidance - 2022
- New Mobility Aids Action Group - 2021
- AIR Hackathon - Reduced Mobility - 2020

Conclusion and special thanks

The lessons learned are priceless

Opportunities to connect and network with highly passionate and skilled people

A special thanks to:

Sanna Kalmari, Atso Ahonen, and Joshua Wintersgill

A large yellow triangle is positioned in the bottom right corner of the slide, pointing towards the top right.

References

Airbus. Space-Flex. URL: <https://services.airbus.com/en/in-flight-experience/cabinupgrades/optimisation/space-flex.html>

EC 1107/2006 PRM legislation. 2006a. URL: <https://eur-lex.europa.eu/legal-content/EN/ALL/?uri=CELEX%3A32006R1107>

US Department of Transportation, PART 382—NONDISCRIMINATION ON THE BASIS OF DISABILITY IN AIR TRAVEL 2020b. <https://www.ecfr.gov/cgi-bin/textidx?SID=ae47679a5dc0b0cdd685abc7e3437dbb&mc=true&node=pt14.4.382&rgn=div5>

Regulations.gov Accessible Lavatories on Single-Aisle Aircraft; Part 1. URL: <https://beta.regulations.gov/document/DOT-OST-2019-0180-0017>

Regulation.gov Accessible Lavatories on Single-Aisle Aircraft: Part 1 Notice of Proposed Rulemaking URL:<https://beta.regulations.gov/docket/DOT-OST-2019-0180/document>.

Curb Free with Cory Lee URL: <https://www.facebook.com/search/top?q=curb%20free%20with%20cory%20lee>

Palmuasema <https://www.palmuasema.fi/>

Joshua Wintersgill <https://ablemove.co.uk/>

All Wheels Up <https://www.allwheelsup.org/>

LOSA CABIN

Line Operations Safety Audit

Danilo Mirabetti – Cabin Safety Analyst

Renata Garcia – Cabin Standards Specialist



06/16/2022

Welcome!

GOL | Crew Members



766

Pursers

2220

Flight
Attendants

2986

cabin crew
members

GOL | Fleet

21 Boeing 737-700

89 Boeing 737-800

34 Boeing 737-Max 8



GOL

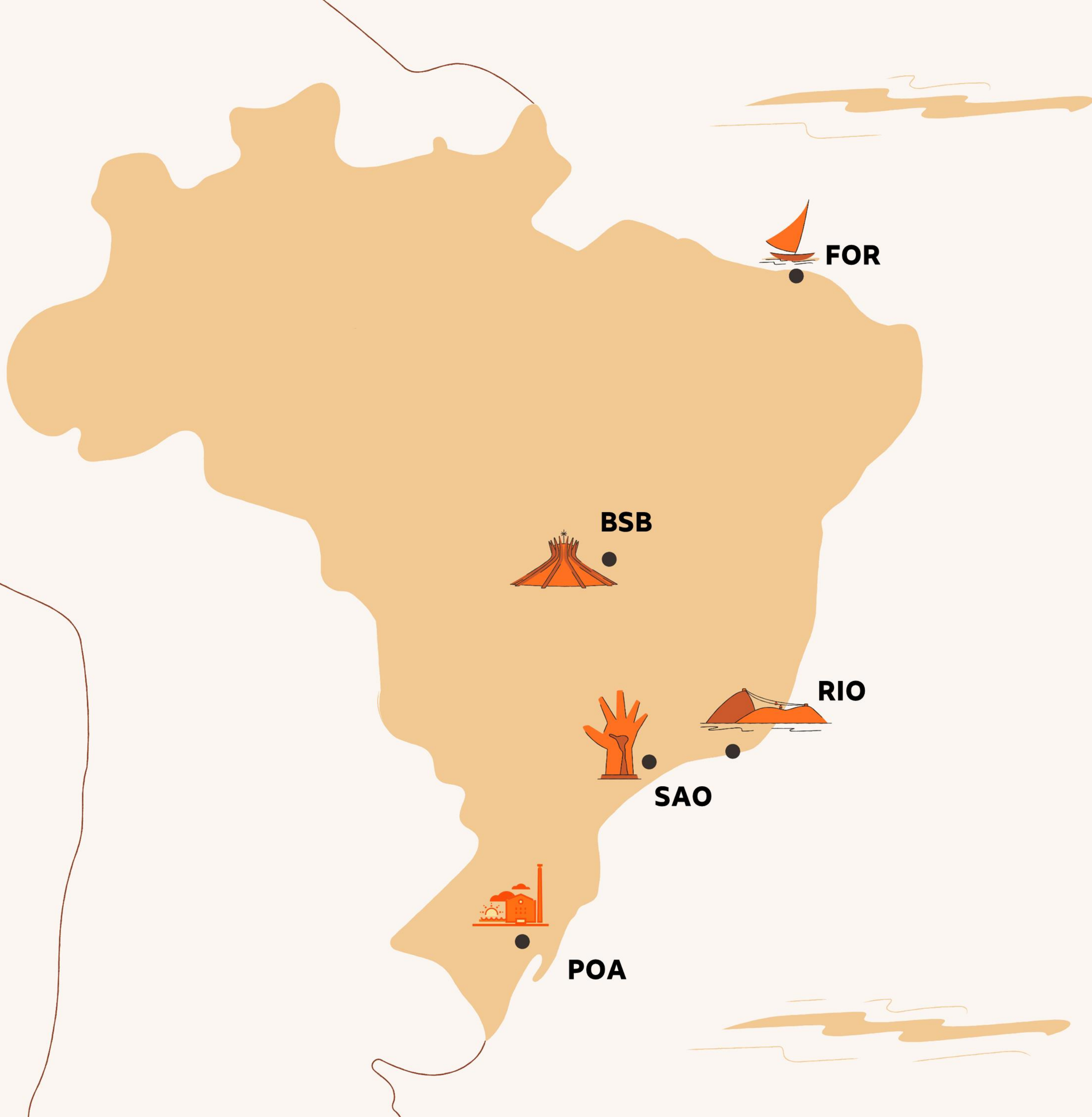

GOL | Crew Hubs

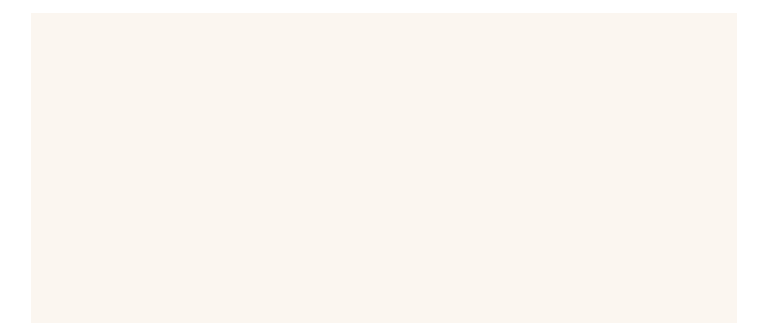

LOSA CAB | Goals and Methodology

- Since 2001 flight crews have been using the program to improve safety.
- Threats and errors are identified and managed before they lead to incidents and accidents
- The methodology used came from the evolution of the Crew Resources Management (CRM)
- The adaptation from Flight into other operational areas is highly recommended, like cabin operations



LOSA CAB | Safety Objective

- 2017: first mention
- 2021: contracted as Safety Objective
- Low cost
 - training
 - observations
 - meals



LOSA CAB | GOL

Cost



Areas involved



Implementation time



SCHEDULE

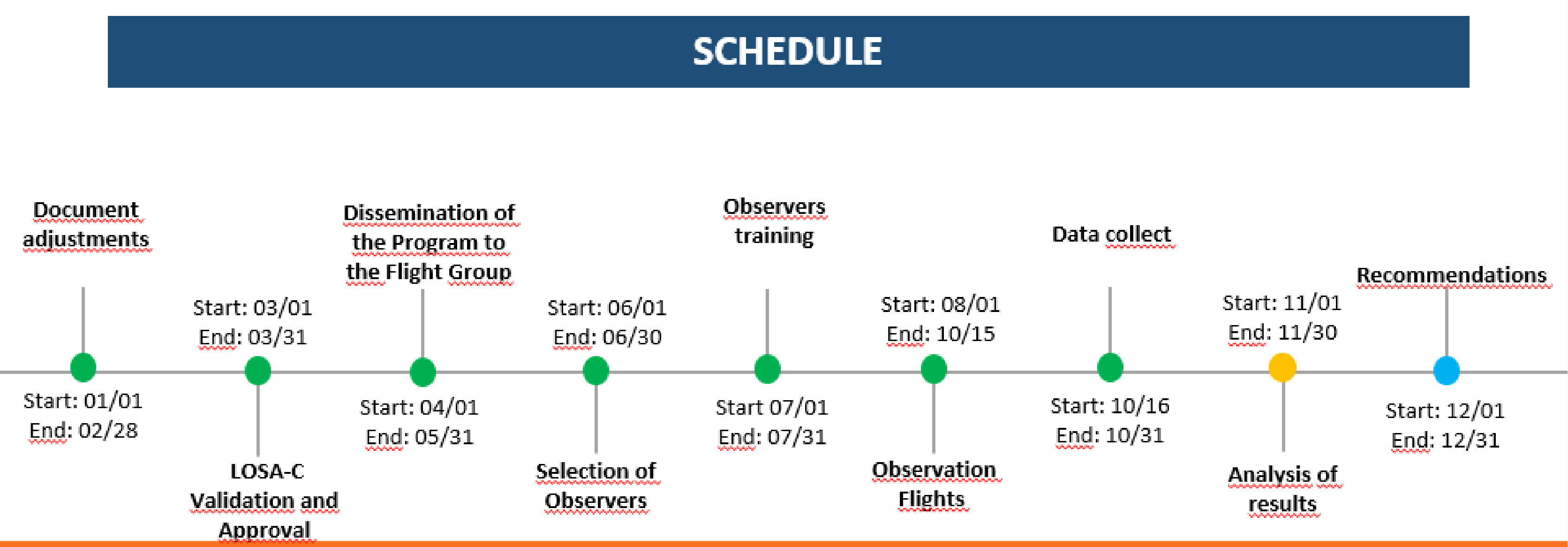

LOSA CAB | Communication



Comunicação de Operações

27 de abril de 2021 · 🌐



Tripulação de Cabine,

Conforme divulgado na [Semana de Segurança no Workplace](#), a implementação da meta-projeto **LOSA CAB** é um dos Objetivos de Segurança de Operações para o ano de 2021.

O **LOSA CAB** será realizado nos mesmos moldes do **LOSA FLT**, com caráter voluntário, sigiloso e não punitivo, visando aprimorar e/ou criar procedimentos que atuem como barreiras de segurança na cabine de passageiros e nas rotinas dos tripulantes de cabine.

As inscrições para a função de Tripulante de Cabine Observador **LOSA CAB** estão abertas até 06/05/2021!

O [link](#) para o Formulário de Inscrição foi enviado aos e-mails corporativos dos Chefes de Cabine e Comissários no Comunicado "**LOSA CAB / Inscrições para Processo Seletivo**", em 27/04/21, com maiores informações sobre o projeto e pré-requisitos para a função.

Bons voos!

#objetivosdesegurancaoperacoes #segurancaoperacional

GOLNOAR

LOSA CAB
Inscrições para o processo seletivo

Link enviado por e-mail para a Tripulação de Cabine

GOL20anos

Objetivos de Segurança Cabin Nova Meta Projeto

Desenvolvimento e implantação do **Line Operations Safety Audit (LOSA)** para a Tripulação de Cabine com o objetivo de aprimorar a **Segurança nos procedimentos e atividades** por meio do programa de observação nos voos.

Segurança Operacional

LOSA CAB | Threat and Error Management - T.E.M. Methodology

What do cabin crews do to safely fly from A to B?

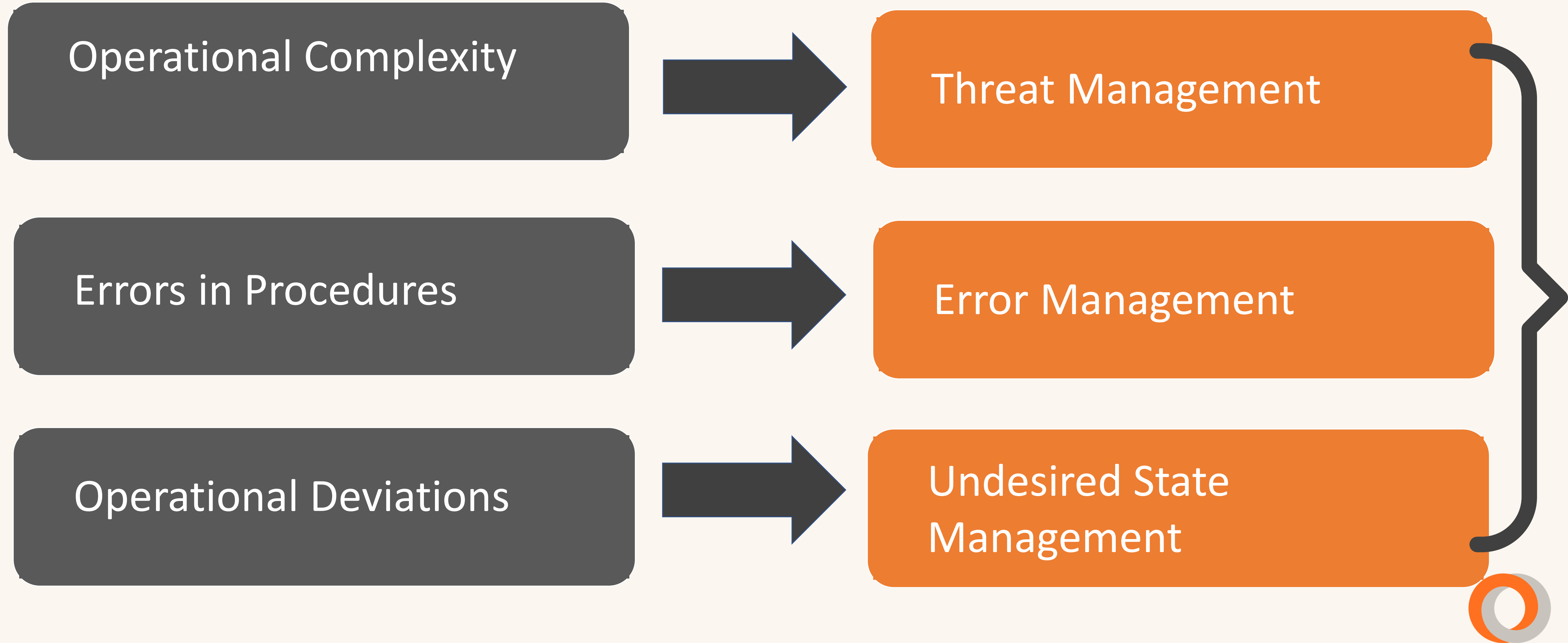

LOSA CAB | Threat and Error Management

T.E.M. Methodology

- **Threats:** external events and / or situations that cabin crew must manage to maintain adequate safety margins
- **Errors:** procedures badly executed or forgotten by the cabin crew, as well as situations badly managed, which might lead to an undesired state
- **Undesired states:** vulnerable states of the operation, as a result from a mismanaged threat or error made, which clearly compromised safety



LOSA CAB | Threat and Error Management

T.E.M. Methodology

Benefits of T.E.M.

- Framework to identify operational strengths / weaknesses and provide prevention strategies
- It takes a photograph from the airline safety maturity in the present time
- Data standardization tool to develop prevention strategies based on analytical findings



LOSA CAB | Characteristics



- Crew have the right to decline a LOSA observation
- Typical denial rate is very low: **1 / 100 flights**
- Our experience was: **0**



- No identifying information
- Collected data for safety purposes only



- Observed crew identity kept anonymous
- No disciplinary action



LOSA CAB | Characteristics



- Selection process
- Training

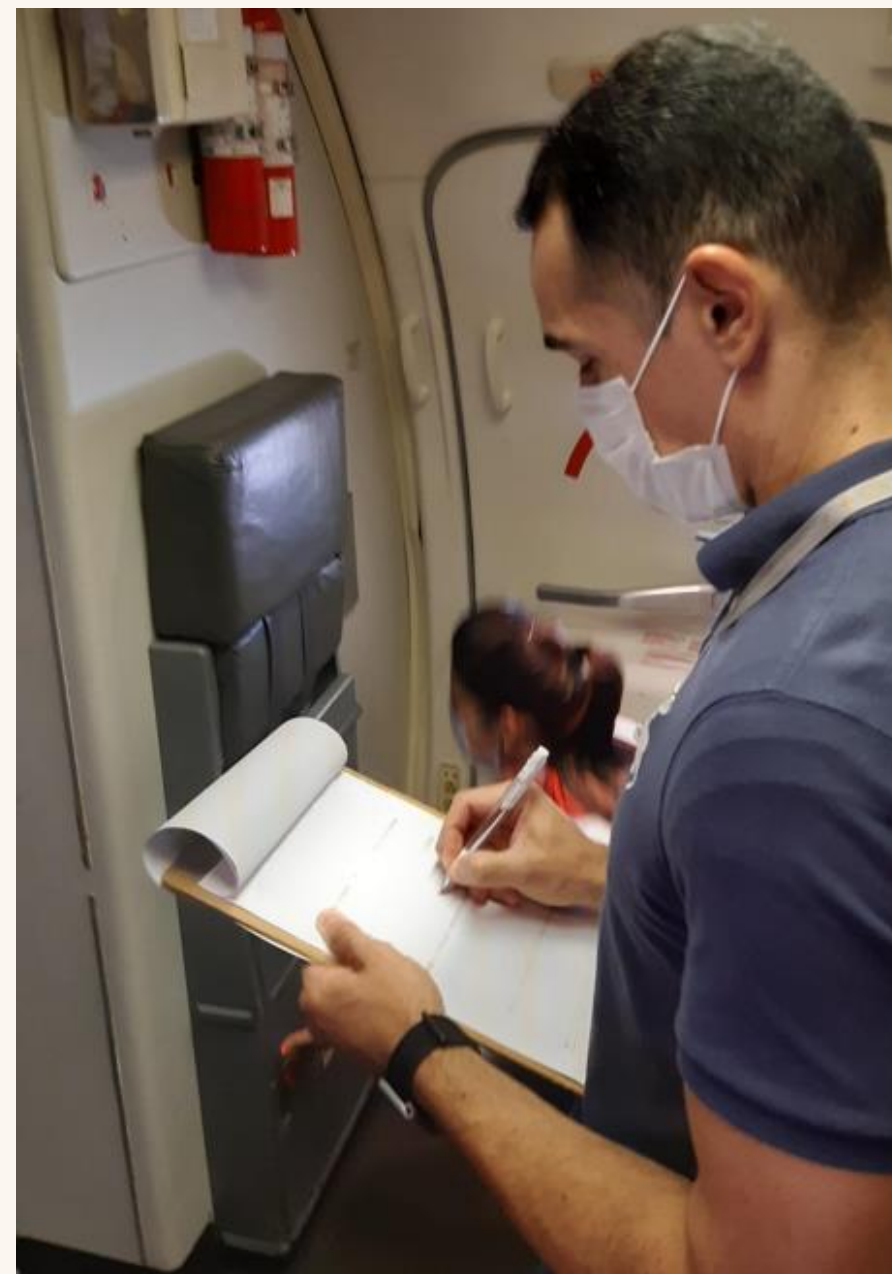

- Regular flights only
- No line checks or training / instructions flights



- Presentation of the results to the stakeholders



LOSA CAB | Selection

Profile:

- Analytical
- Attentive
- Detail
- Safe
- Calm
- Updated



LOSA CAB | Eligibility Criteria



- Minimum time in the role
- No remarks in the file
- Not being part of another cabin crew administrative program
- Not being an instructor or checker



LOSA CAB | Selection

Number of subscribers: 84

- Group activities / Tests / Case studies
- Personal interview
- Approval of finalists
- Publication of the approved



LOSA CAB | Observers



LOSA CAB Observação em Voo

Conheça os selecionados para participar do programa.
Parabéns!



Alex Romão
Comissário - CGH



Victor Meneses
Chefe de Cabine - BSB



Elissandra Renda
Comissária - GRU



Raphael Gonçalves
Comissário - GIG



Sannino
Chefe de Cabine - GRU



Raquel Mioko
Chefe de Cabine - GRU



Rômulo Dias
Comissário - BSB



Mario Tavares
Comissário - CGH



Dani Bandeira
Chefe de Cabine - BSB



Isabela Fuhrmann
Comissária - CGH



Ricardo Martins
Chefe de Cabine - FOR



Diana Jaffe
Chefe de Cabine - CGH



Robson Santos
Comissário - GRU



Marcelo Foglio
Comissário - CGH



João Marcelo
Comissário - POA



Priscila Fonseca
Comissária - CGH



Natalia Moreira
Comissária - GRU



Civalli
Comissário - CGH



Luciano Martins
Chefe de Cabine - FOR



Jacson Gross
Chefe de Cabine - POA

LOSA CAB | Training

- CRM Evolution
- T.E.M. methodology
- Crew approach
- Filling out forms
- Familiarization with the data system
- Transcribing form data into the system



LOSA CAB | Challenges During Observations



- Narrow-body aircrafts only

GOL	FORMULÁRIOS LOSA-CAB	DATA: 14/08/2021
		Página 7/8
	FORM-PR-ORG-DX-013-001 - FORMULARIOS LOSA-CAB	Rev: 00

Passageiro alcoolizado	Evento cabine de comando			
Passageiro abusivo	Falha da aeronave			
Erro colocação de escada/rampa de acesso para embarque/desembarque	Evento com manutenção			
Tráfego congestionado no solo ou em voo	Evento com ground handling			
Outras ameaças externas	Evento com pessoal do despacho operacional (documentação)			
Bagagem oculta com itens proibidos	Manuais incompletos/incorretos			
	Procedimentos operacionais inadequados			
	Liberação de assentos (free seat)			
	Procedimentos incompletos no check in			
Tabela de tipos de erros				
PROCEDIMENTOS				
COMUNICAÇÃO				
Erros no cheque de equipamentos	Erros de comunicação entre a tripulação			
Erros de briefing	Erros de comunicação com o despacho			
	Erros de comunicação com manutenção			
	Outros erros de comunicação			
Tabela de tipos de estados indesejados				
APRESENTAÇÃO	EMBARQUE	STERILE COCKPIT	SERVIÇO DE BORDO	DESEMBARQUE
Briefing	Portas desguarnecidas	Comunicações não permitidas	Trolley's danificados	Erro procedimento de portas
Power distance	Erro procedimento de portas			
Registro de Ameaças				
Tipo de ameaça:				
<input type="checkbox"/> Ameaça na saída ou no chegada				
<input type="checkbox"/> Ameaça operacional				
<input type="checkbox"/> Ameaça da cabine				
<input type="checkbox"/> Ameaça do pessoal de apoio				
<input type="checkbox"/> Outra ameaça				



- Covid-19 Pandemic

- Adapt the forms from pilots into the cabin environment
- Define threats, errors and undesired states for LOSA CAB



LOSA CAB | Familiarization with the Forms

- | T.E.M. concepts included
- | Demographic data
- | Observers own perceptions on contributing factors
- | Examples of:
 - Threats
 - Errors
 - Undesired states

	FORMULÁRIOS LOSA-CAB	DATA: 14/06/2021
		Página 4/8
		Rev.: 00
FORM-PR-ORG-DX-013-001 - FORMULÁRIOS LOSA-CAB		
Fase do voo em que a ameaça foi verificada		
<input type="checkbox"/> Pré Voo/Taxi-out <input type="checkbox"/> Decolagem/subida <input type="checkbox"/> Cruzeiro <input type="checkbox"/> Descida/pouso <input type="checkbox"/> Taxi-in		
Quem identificou a ameaça?		
<input type="checkbox"/> Chefe de Cabine <input type="checkbox"/> Comissário auxiliar <input type="checkbox"/> Outros Quem?		
Natureza da ameaça		
<input type="checkbox"/> Externa <input type="checkbox"/> Organizacional <input type="checkbox"/> Tipo de ameaça:		
Houve gerenciamento da ameaça?		
<input type="checkbox"/> Sim <input type="checkbox"/> Não		
Como foi o gerenciamento da ameaça?		
<input type="checkbox"/> Adequado <input type="checkbox"/> Inadequado		





LOSA CAB | Data Analysis

Sample

229
observed
flights

• Observations focused on:

- ✓ Briefings
- ✓ Documentation
- ✓ Emergency Equipment Checks
- ✓ Management Situations in the Passengers Cabin
- ✓ Cabin Checks
- ✓ General Safety Procedures
- ✓ Situational Awareness
- ✓ Compliance with normatives
- ✓ CRM

Identified Events (578)

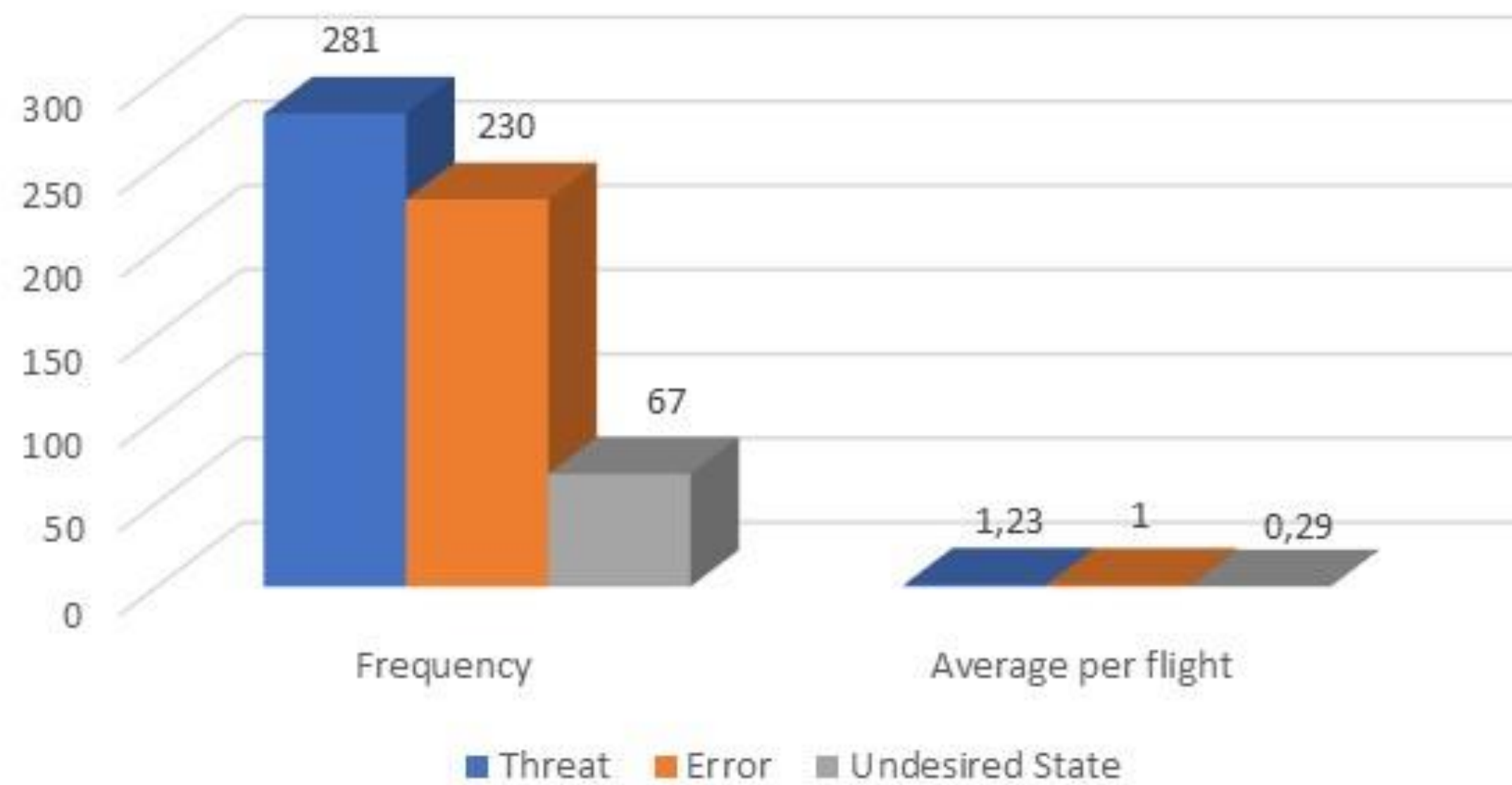

LOSA CAB | Results - Phases of the Flight

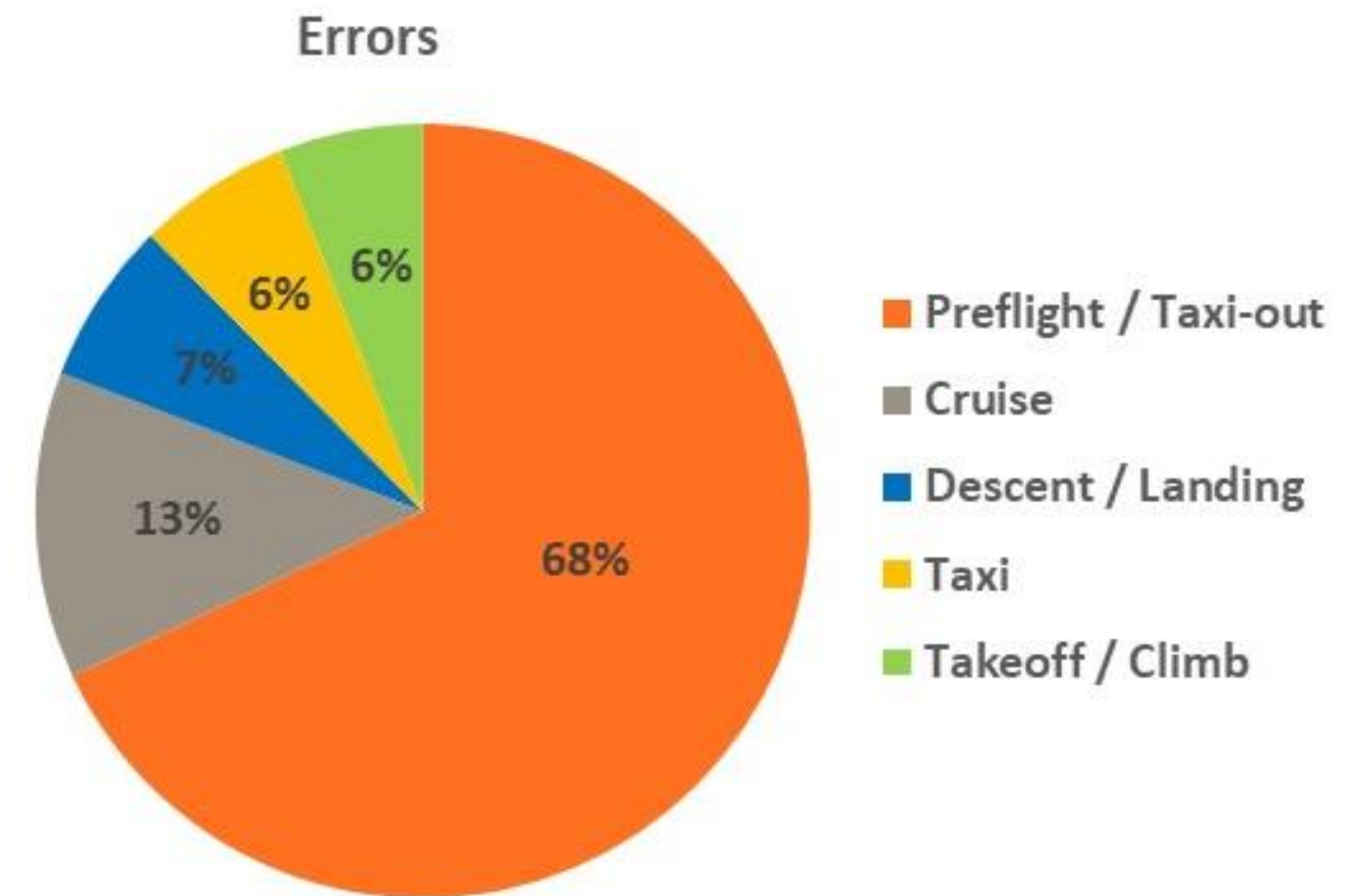
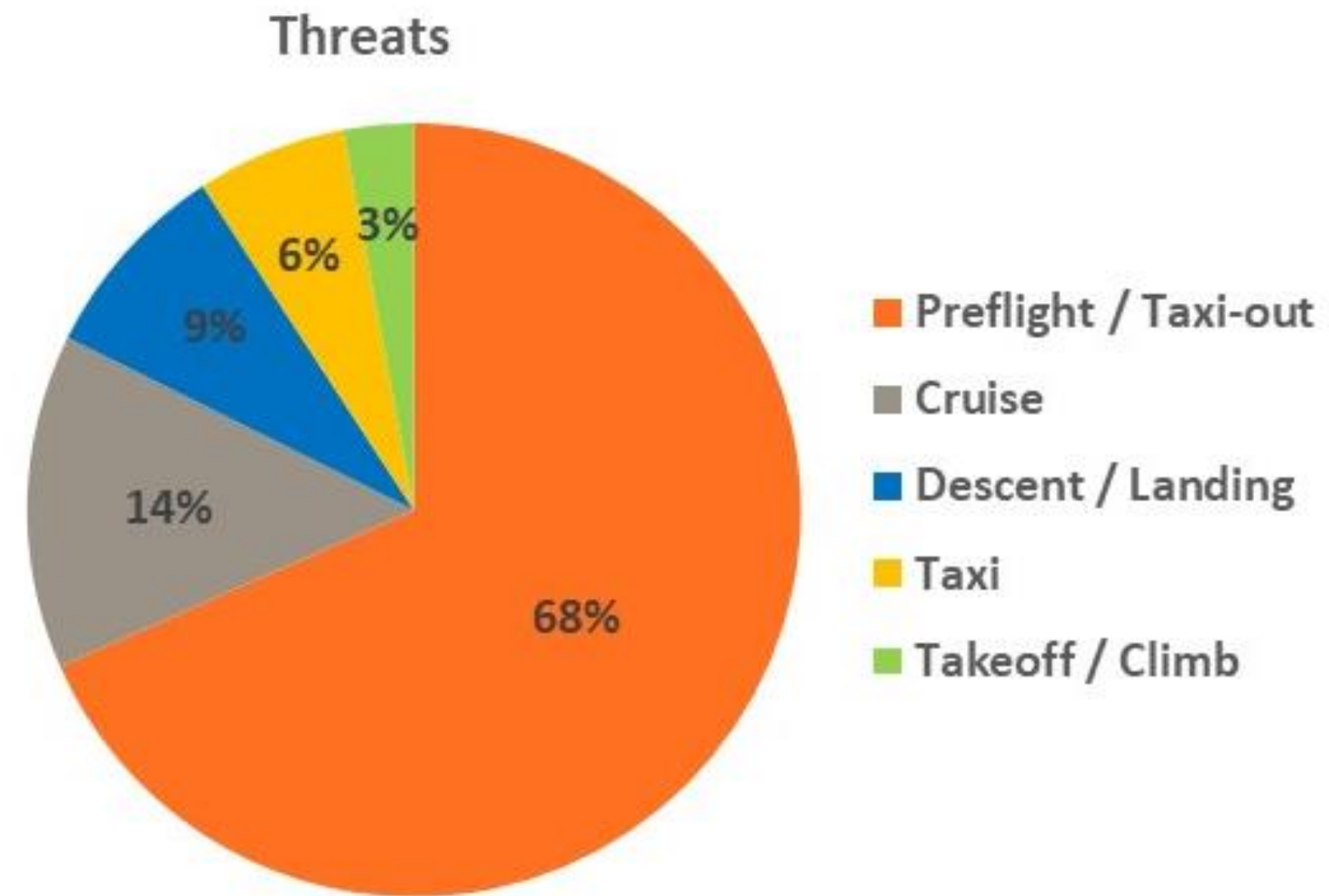

Undesired States

- Preflight / Taxi-out: 70%
- Taxi: 14%



LOSA CAB | Results

- ✓ Reduced situational awareness level in operations with aircrafts on the ground focused on *Pre-Flight* and *Taxi-Out* phases.
- ✓ Regarding fatigue, it revealed acceptable rates from the point of view of operational safety, not requiring mitigation from the departments involved.



LOSA CAB | After Observations

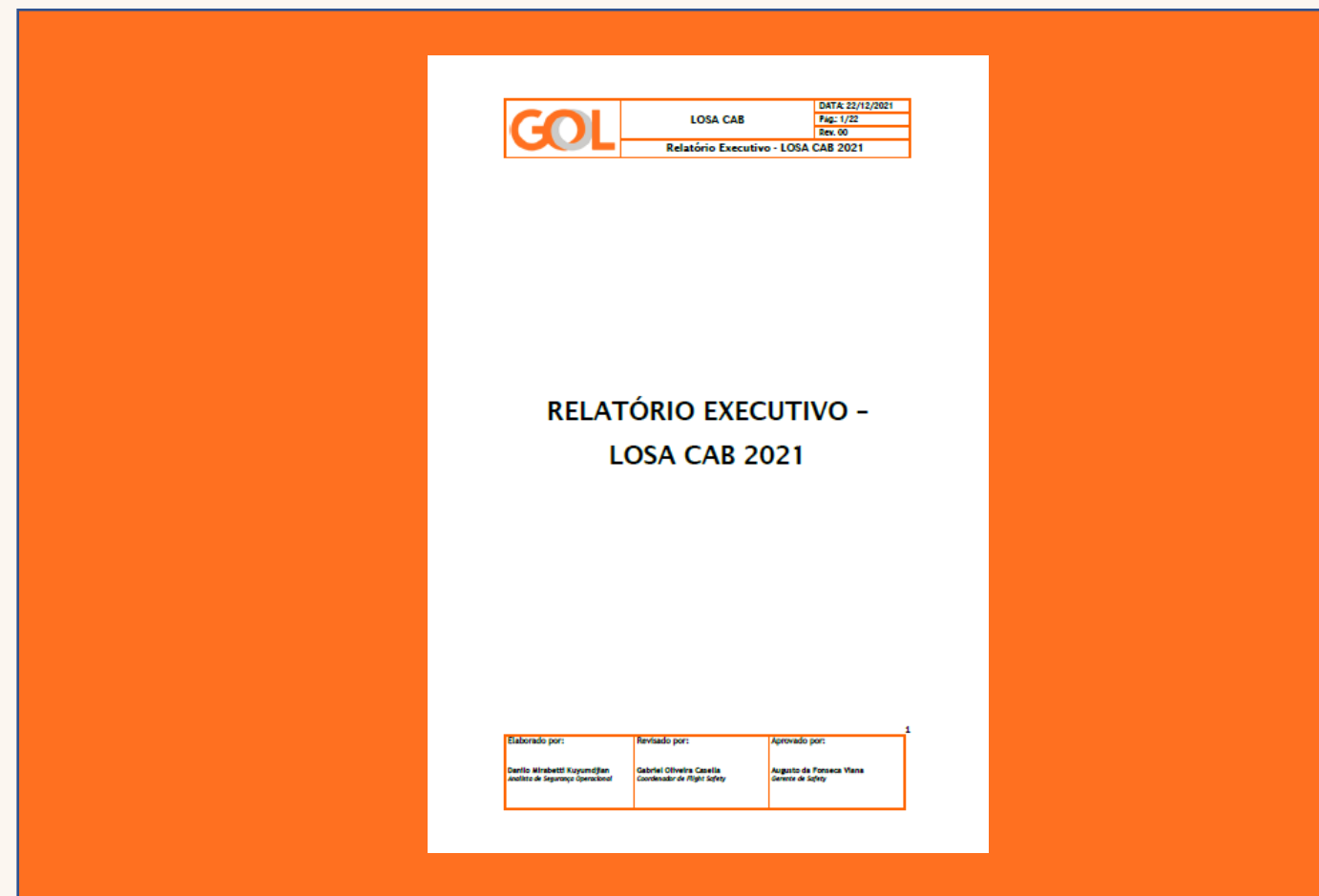

Final Report

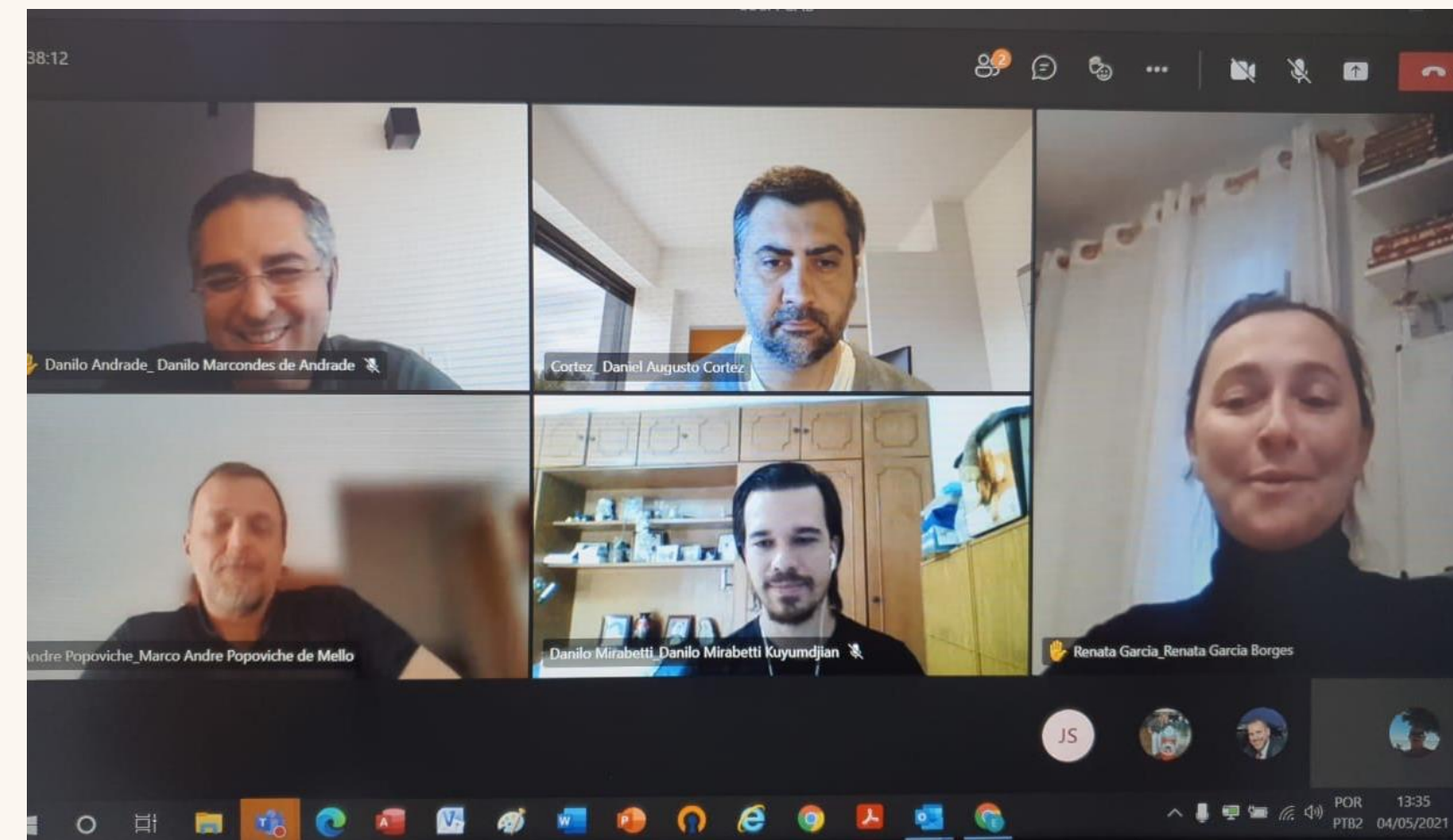

Directors and managers



Results and certificates to observers



LOSA CAB | **Future Actions**

- ✓ Presentation of LOSA CAB results to cabin crew
- ✓ Campaigns on Workplace
- ✓ Use of publications to reinforce procedures
- ✓ Emphasis on some topics during training
- ✓ Agendas in operational meetings with cabin crew
- ✓ Review the effectiveness of some procedures



LOSA CAB | Lessons Learned



 **INSTRUÇÃO SUPLEMENTAR – IS**
IS Nº 00-010
Revisão A

Aprovação: Portaria nº 1495/SPO, de 5 de junho de 2020.
Assunto: Treinamento de Gerenciamento de Recursos de Equipes (Corporate Resource Management - CRM) **Origem:** SPO

1. OBJETIVO

1.1 Estabelecer critérios e procedimentos para implementação e manutenção de um Programa de Treinamento de Gerenciamento de Recursos de Equipes (Corporate Resource Management - CRM).

1.2 Esta IS se aplica aos operadores aéreos regidos pelos RBAC nº 90, 121 e 135.



Establishes a baseline for future comparisons

Elevates CRM

Credibility in Aviation Community



LOSA CAB | **Lessons Learned**



Value for money



Communication



And the most important...



LOSA CAB | Testimonials



LOSA CAB | Thank you



GOL



**Besides work,
a friendship!**



GOL



Danilo Mirabetti – dmkuyumdjian@voegol.com.br
Renata Garcia – rgborges@voegol.com.br

SUPPORTING AIRLINES & CABIN CREW THROUGH THE CRISIS

RICHARD GOMEZ
VICE PRESIDENT OF GLOBAL PRODUCT DEVELOPMENT AND DESIGN
MEDAIRE, INTERNATIONAL SOS

MedAire
An International SOS Company

35 YEARS OF PROVIDING Intelligence, advice & assistance to

PRIVATE AVIATION
4500+ AIRCRAFT



75%
OF FORTUNE'S TOP 100
COMPANIES' CORPORATE
AIRCRAFT

COMMERCIAL AVIATION
180+ AIRLINES



67%
OF WORLD'S TOP
COMMERCIAL AIRLINES

LUXURY YACHTS
1100+ YACHTS



50%
OF WORLD'S
SUPERYACHTS

GLOBAL CAPABILITIES EXPERT CARE, EVERYWHERE.



27
Assistance Centres



5
Regional Security Centres



5,200
Medical Professionals



200
Security Professionals &
2000 Security Providers



91,800
Accredited Providers

 MedAire Office

 Medical Supply
Fulfilment Centre

 International SOS 24/7
Assistance Centre & Office

 Security Intelligence &
Operations Centre

 International SOS Office

 Security Operations
(dedicated security analysts)



Mumbai to Miami, Dubai to Dakar, London to Lagos.
Wherever you fly, MedAire is there.

BE SURE
TO WASH YOUR
HANDS AND ALL
WILL BE WELL.

COVID-
19

RECESSION



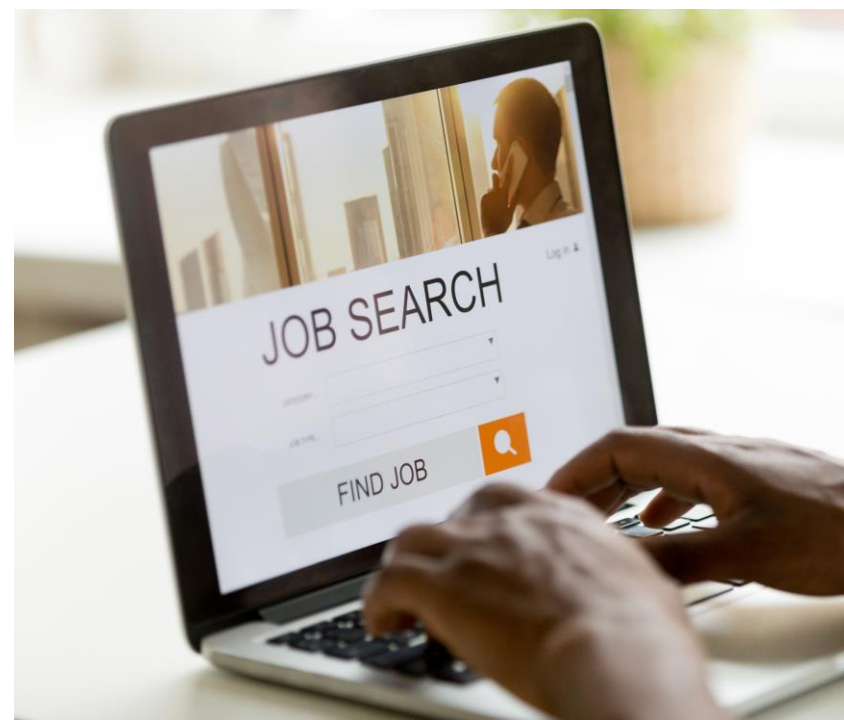
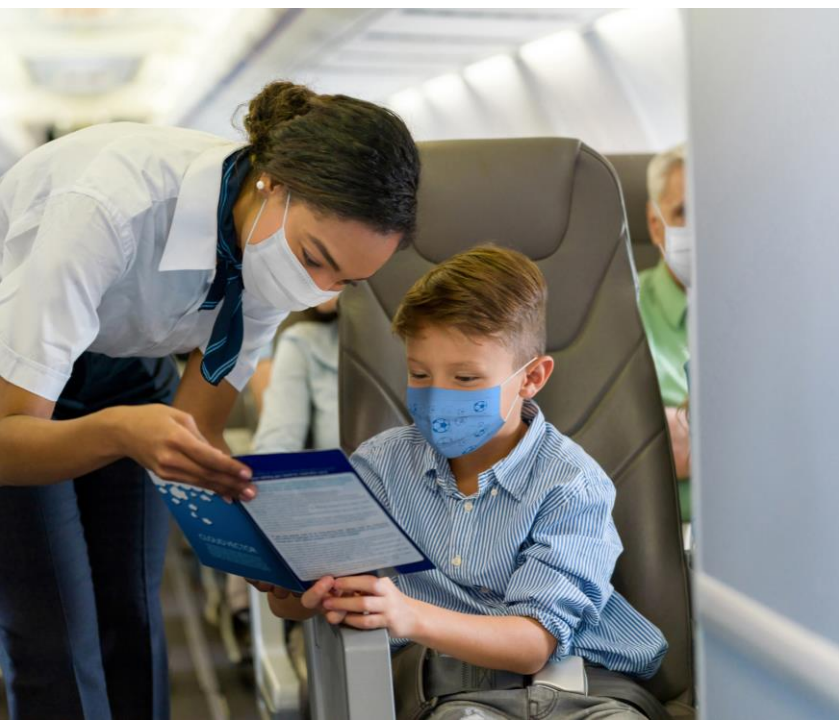

ADAPT, PIVOT AND FIGURE IT OUT

- Who – Crew
- What – How to safely fly
- When – Now and beyond today..



**#NEW
NORMAL**

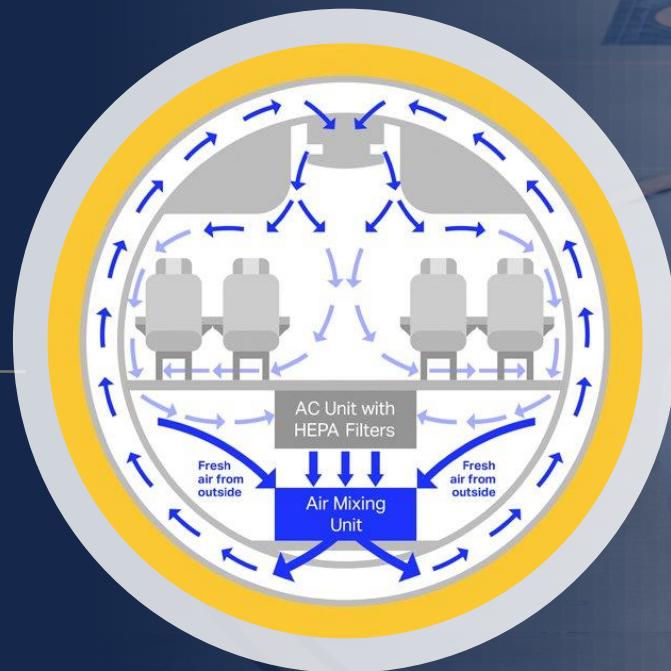

CDC Proclaims: Coronavirus COVID-19 is aerosolized

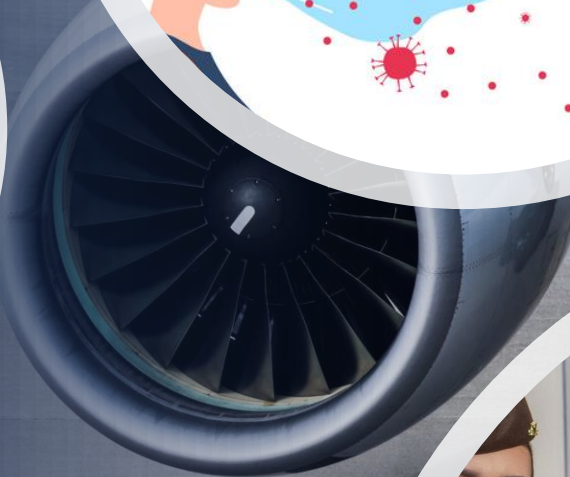
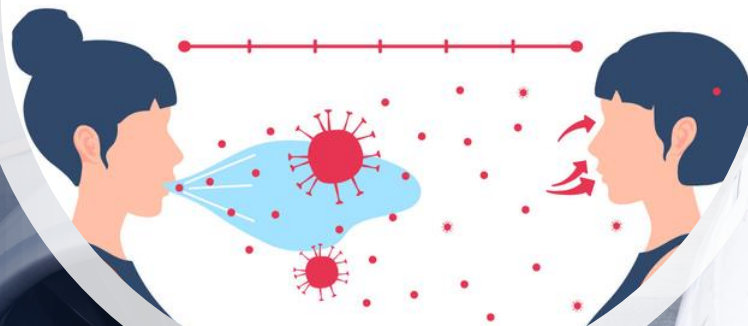

AIRLINES AROUND THE WORLD



WE ARE ALL JUST
PEOPLE

IT'S ALL ABOUT YOU!

COVID IMPACT

IN 2021 MEDAIRE
ASSISTED WITH

3,000+

COVID RELATED
CASES

22.3%

OF COMMERCIAL
AIRLINES CREW
SUPPORT CASES WERE
FOR INFECTIOUS
COMMUNICABLE
DISEASES

IN 2020

**11 MEDICAL
DIVERSIONS**

WERE RELATED TO
INFECTIOUS
COMMUNICABLE
DISEASES

CASE STUDY

After arriving in Hong Kong, a Pilot called concerned about a sick colleague he flew with 3 days prior. He started to feel very sore, had a 101° F (38.3° C) temperature during the flight, with congestion and headache; but no sore throat or cough.

Call MedAire for Advice & Assistance

FLIGHT DECK COVID EXPOSURE

CASE STUDY



MedAire arranged a doctor appointment via the Teleconsultation App from the Pilot's hotel room. MedAire also dispatched a courier from the Hong Kong Assistance Centre to deliver the test and transport the sample to the lab for analysis; Expediting the process with results available the next day.



The Pilot's condition deteriorated overnight, so MedAire requested a physical evaluation by a house call doctor.



Fortunately, the COVID result was negative, and the Pilot began to feel better. He returned home after he completed a 10-day isolation given his symptoms were consistent with COVID, history of close contact and risk of false negative test. He was able to do this from his hotel room rather than a government run facility; where he would have gone had he tested positive.

FLIGHT DECK COVID EXPOSURE

MENTAL HEALTH AND WELLBEING

A total of 125 cases were categorized as Mental Health (1.5%)

Period of Jan 1, 2021, to May 23, 2021

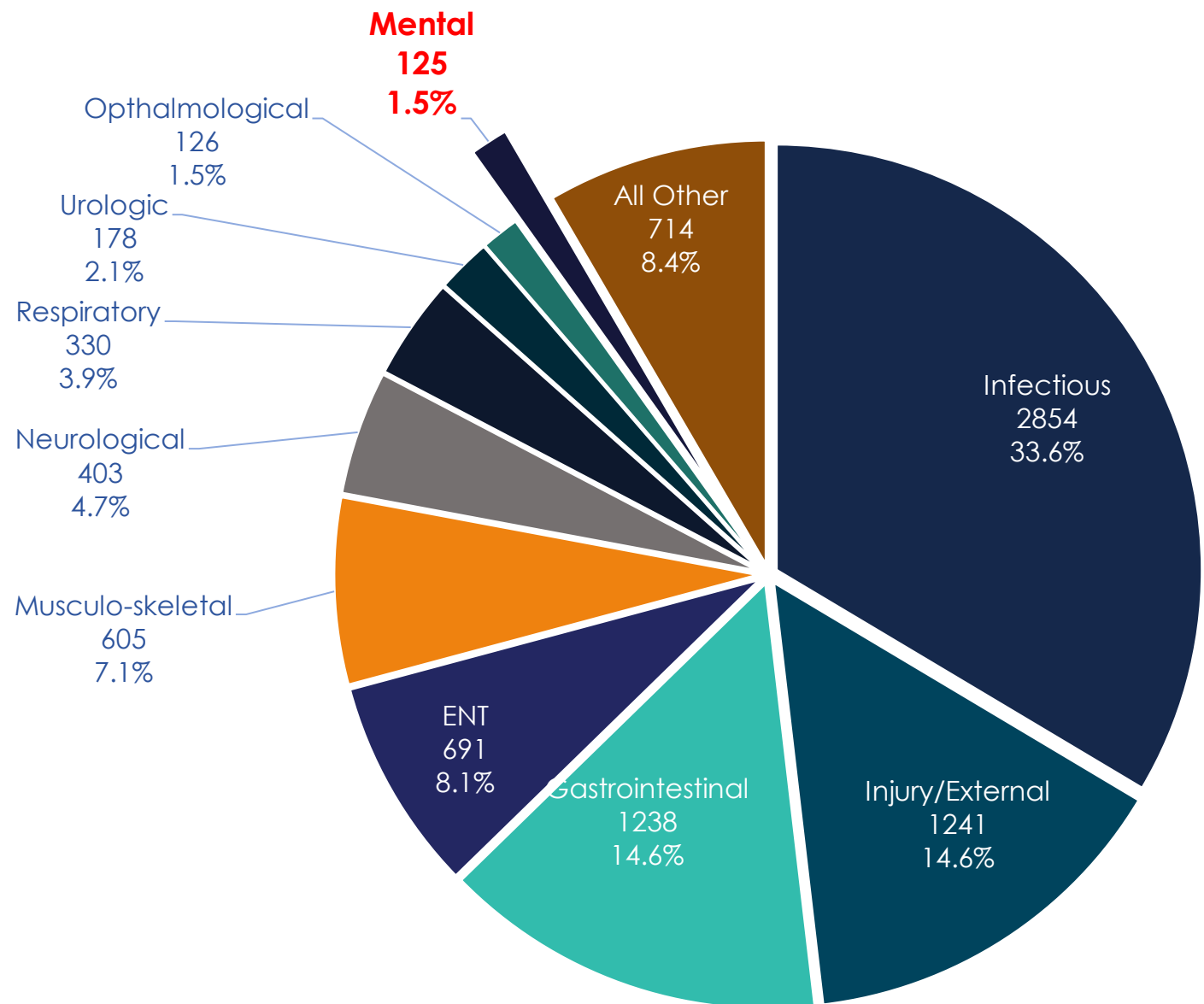

Monthly Evolution of Mental Health 2018-May 2022

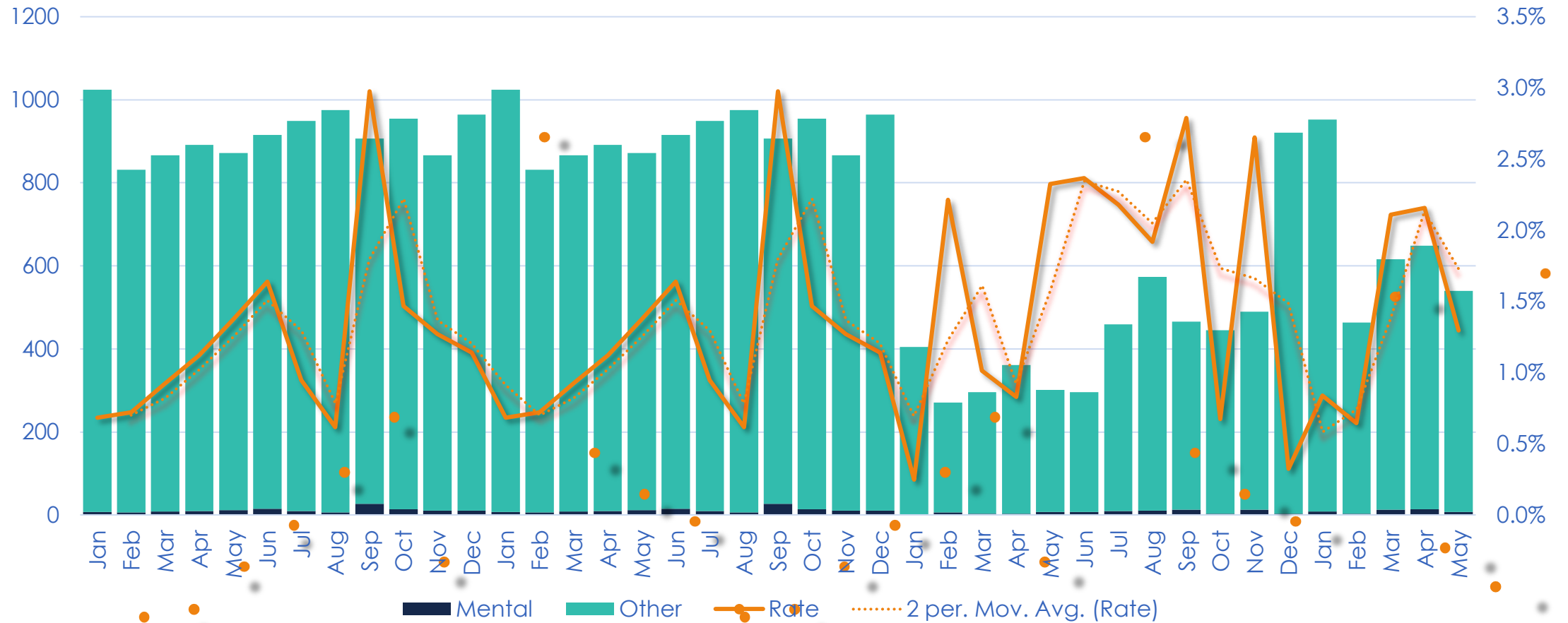

Duty Status Mental Health Cases

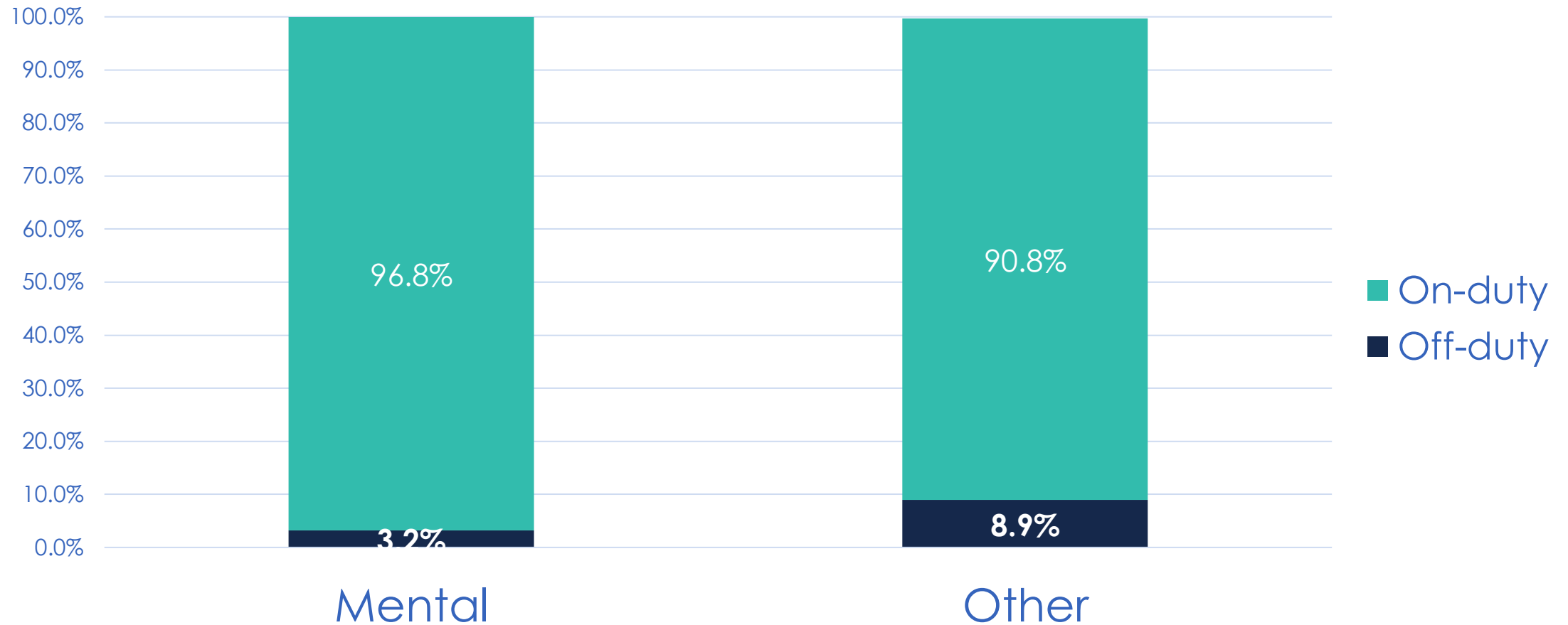

MENTAL HEALTH & **EMOTIONAL SUPPORT**

► Mental Health

- Emotional Trauma Management Train the Trainer Course
- 24/7 Immediate Emotional Support Triage & Counselling
- Recommendation on Crewmembers Fitness for Duty/Operate



CREW HEALTH

- ▶ Travel Health
 - Prevention
 - PPEs
 - Training



WHILE ON THE ROAD

INFLIGHT AND OVERNIGHT

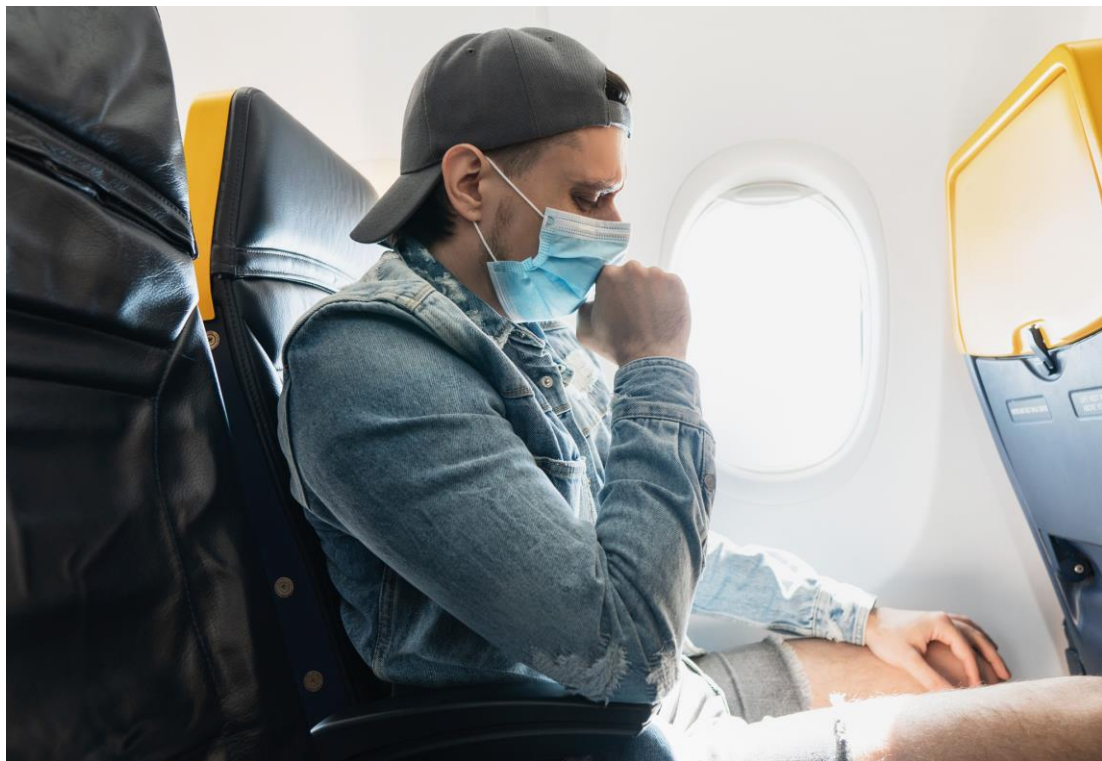

TOAST TO A HEALTHY FUTURE

LOOKING AHEAD

- ▶ IATA “ Global Health” working group
- ▶ Advisory services focused on aviation health
- ▶ Using technology
- ▶ Using science / data driven
- ▶ Communications – Internal and External
- ▶ Partners with a focus on crew health ...



AVIATION APP

DASHBOARD & COUNTRY GUIDES

FULL-ACCESS TO AVIATION SECURITY LIBRARY

REAL-TIME ALERTS W/PUSH NOTIFICATIONS

INFLIGHT

MEDICAL KIT INTEGRATION

- Use the app to scan and register onboard medical kits. MedLink doctors will know your exact kit configuration without needing to ask.

IN-FLIGHT ASSESSMENT TOOL

- Scenario-based tool assists with patient assessment and streamlines communication with MedLink resulting in expedited patient care.

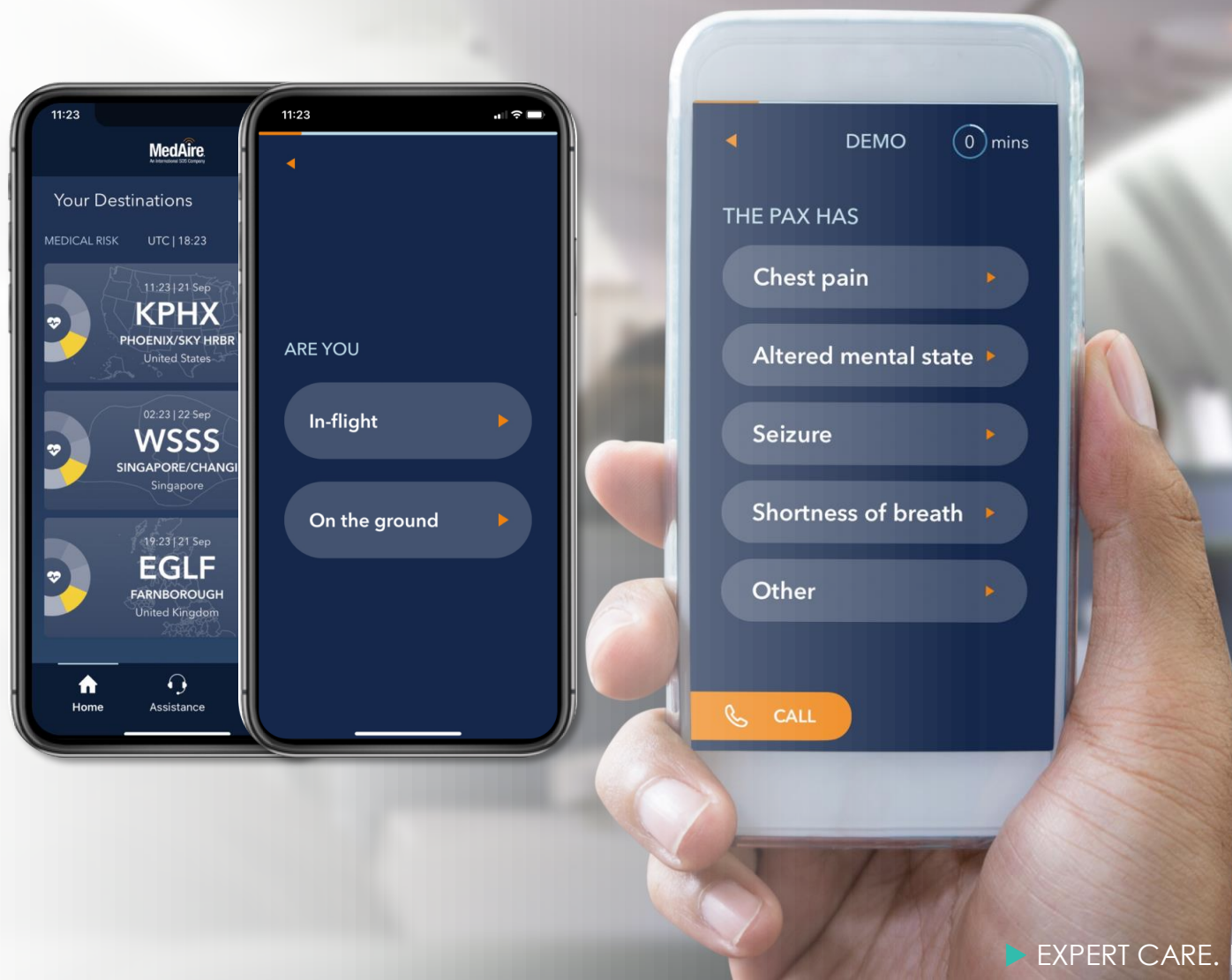

PERSONAL SECURITY SAFE

- Bond's on-demand preventative personal security platform enables access to immediate support from highly trained Personal Security Agents.
- For those situations when a crewmember just wants an added layer of security, the advance technology built into the MedAire/Bond App provides security monitoring features that crewmembers can turn-on or turn-off at any time.
- The crewmember is in control of what level of security they want but always has a level of security when carrying the MedAire Aviation App integrated with the Bond personal security features.

IN 99% OF SITUATIONS WHERE CREW FEEL UNCOMFORTABLE OR UNSAFE – IT IS TOO EARLY TO DIAL EMERGENCY SERVICES, SINCE IT IS NOT YET AN EMERGENCY.

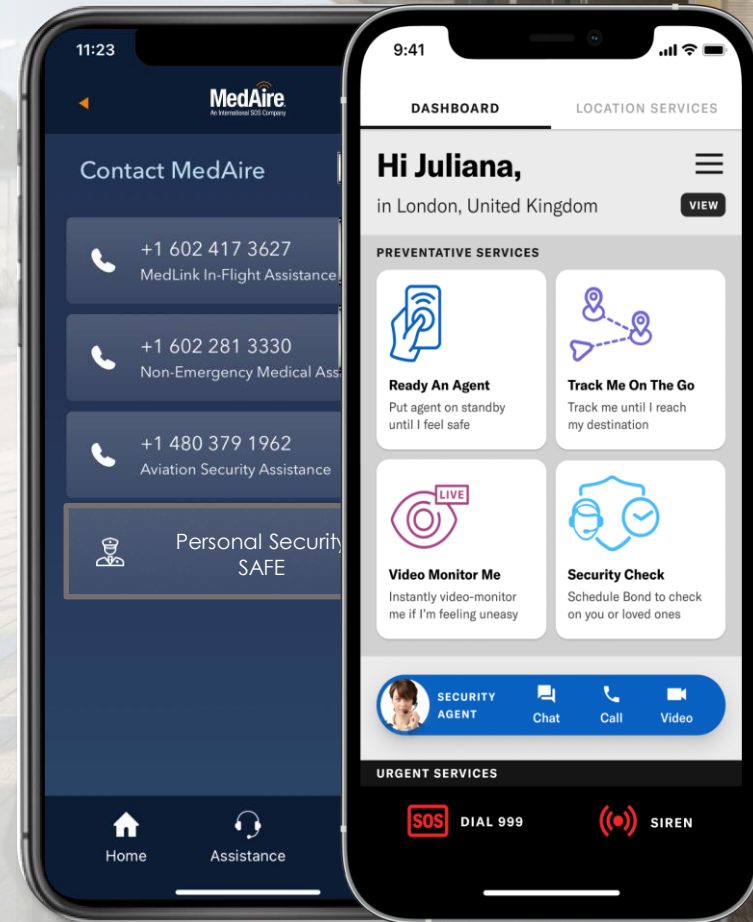



MEDAIRE PORTAL Security and Medical

The portal's map-based interface provides 360 degrees of analysis by integrating the following features:

- ▶ **AIRSPACE ASSESSMENT** visualise risk by flight information regions and flight restrictions or warnings that have been published by major civil aviation governing bodies through a simple click.
- ▶ **ALERT & THREAT VISUALISATION** real-time threats and aviation alerts are displayed on a map.
- ▶ **FLIGHT ROUTE VISUALISATION BETA** upload a flight plan or manually enter a flight route for visualisation against several risk factors.
- ▶ **FLEET TRACKER** enter the aircraft registration numbers and track your assets directly within the portal using a feed made available by FlightAware.
- ▶ **AIRPORT RISK RATING** formerly Go/No Go reports is displayed as an easy-to-understand rating on a colour-coded scale.
- ▶ **INTEGRATED MEDICAL RISK RATINGS and ALERTS** Provides the most current medical information for the region to include medical facilities

Travel Safety Alerts

-  **United States**
Omaha (Nebraska state): Exercise caution in vicinity of South 20th street due to fire at chemical plant (Revised)
May 31 2022 | 11:27 AM UTC
-  **United Kingdom**
Monkeypox cases reported in multiple countries
May 31 2022 | 04:48 AM UTC
-  **United States**
New York City: Normal movement can resume around 42nd Street & 3rd Avenue intersection following police operation (Revised)
May 30 2022 | 07:47 PM UTC
- United Kingdom**



SHARED VISION
TO MAKE YOUR WORKPLACES – AND THE WORLD
A SAFER PLACE



QUESTIONS

FOR MORE INFORMATION:

- VISIT WWW.MEDAIRE.COM/
- CONTACT MEDAIRE AT INFO@MEDAIRE.COM



Airlines for America[®]

We Connect the World

A4A Cabin Ops Collaborative Response to Covid-19

How we are better prepared to handle the next Global Crisis and navigating the aviation industry post pandemic.

IATA Cabin Ops Safety Conference
Lisbon, Portugal

ABOUT US

Airlines for America (A4A) advocates on behalf of its members to shape crucial policies and measures that promote safety, security and a healthy U.S. airline industry. We work collaboratively with airlines, labor, Congress, the Administration and other groups to improve aviation for the traveling and shipping public.

Annually, commercial aviation helps drive nearly \$1.7 trillion in U.S. economic activity and more than 10 million U.S. jobs. A4A vigorously advocates on behalf of the American airline industry as a model of safety, customer service and environmental responsibility and as the indispensable network that drives our nation's economy and global competitiveness.

Cari Smith Allen – A4A Chair – Alaska Airlines | Jay Lee – A4A Co-Chair – United Airlines



A4A Members





A4A Cabin Ops Committee Mission



Airlines for America®
We Connect the World

The mission of the Cabin Operations Committee is to develop, promote, implement and enhance comprehensive passenger and cabin initiatives and training programs that assure safe, efficient cabin operations. Its vision is an accident-free, cost-effective cabin environment for passengers and employees. The Cabin Ops Committee reports to the A4A Safety Council.



Supporting our members through the COVID Pandemic

The A4A Cabin Operations Committee banded together at the start of the pandemic and became the experts our carriers looked to for guidance in **key areas we'd like to share with you today:**



Onboard Mitigations



Cultural-Specific Needs



Safe Onboard Service



Training/Reg. Exemptions

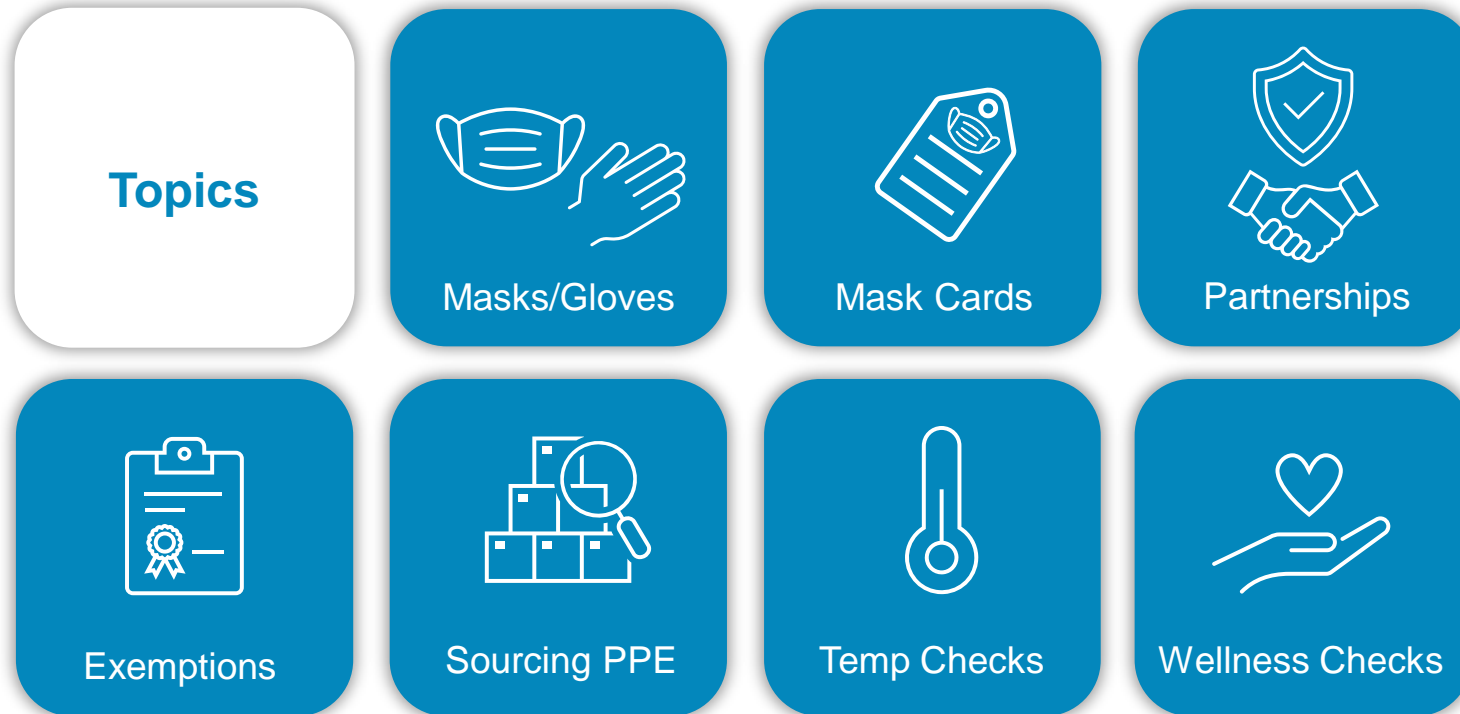

Johnathan Cunningham – Delta Air Lines | Stacey Franz – American Airlines

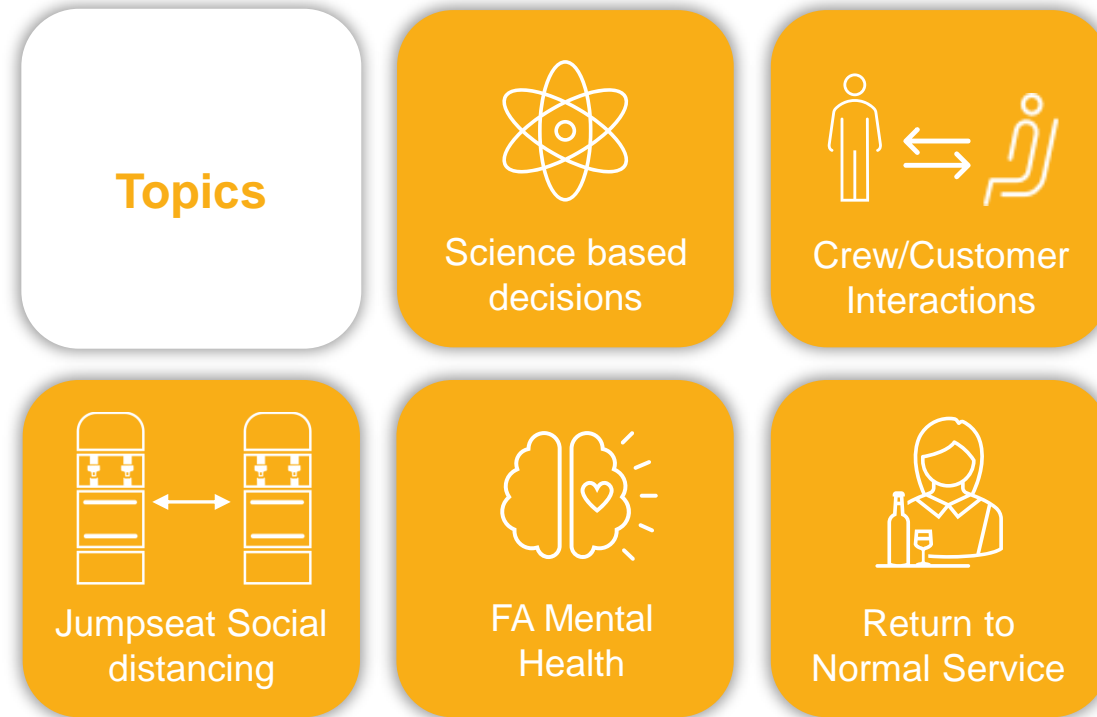

DeWayne Cook – JetBlue Airways | Elise May – Southwest Airlines



Janice Hatton-Santiago – United Airlines | Sarah Vandermark – Southwest Airlines

Timeline

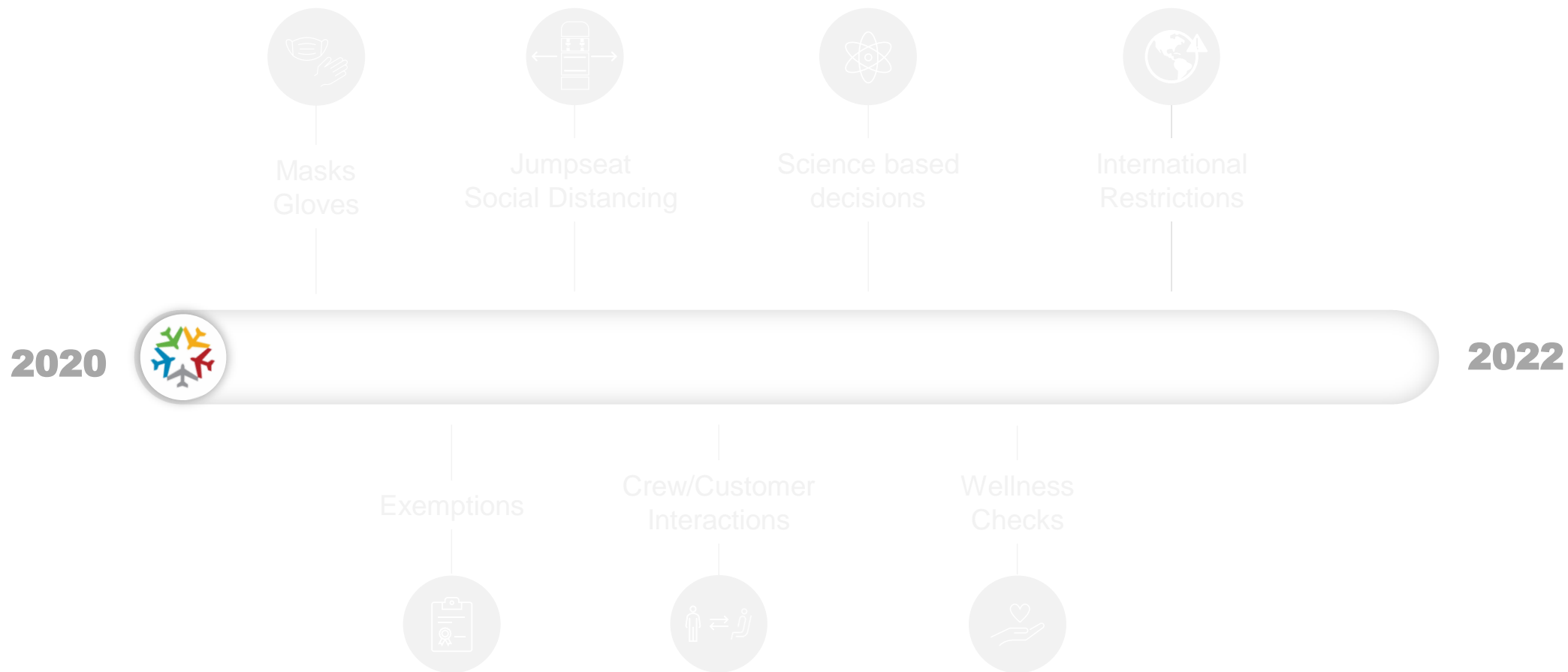

Timeline

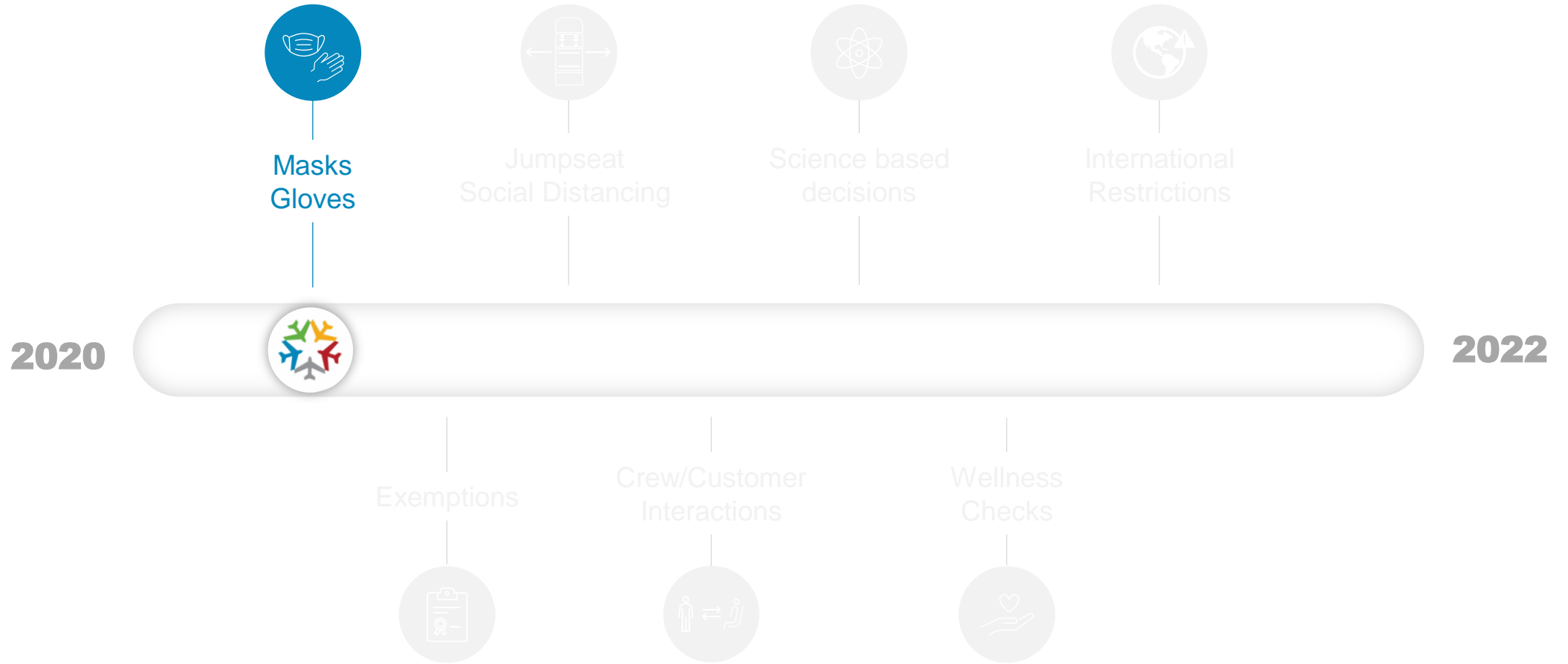

Timeline

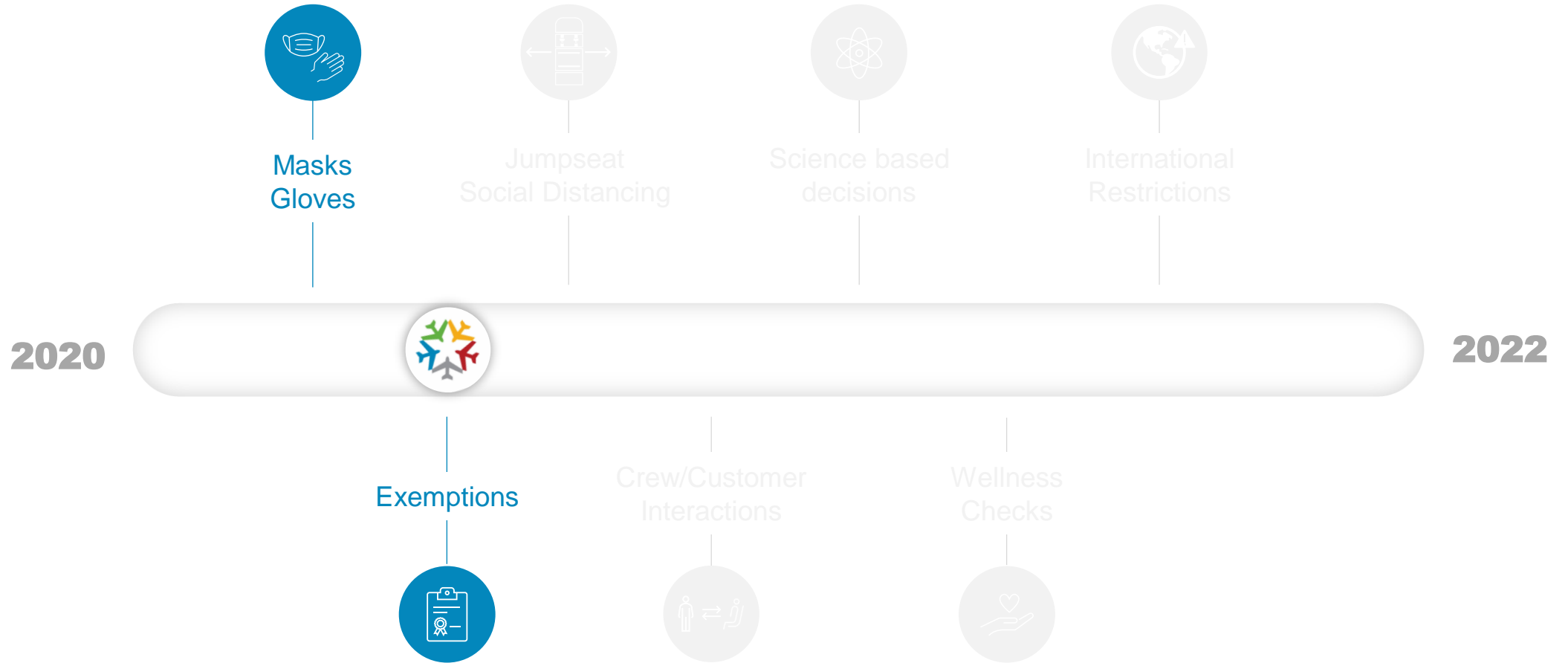

Timeline

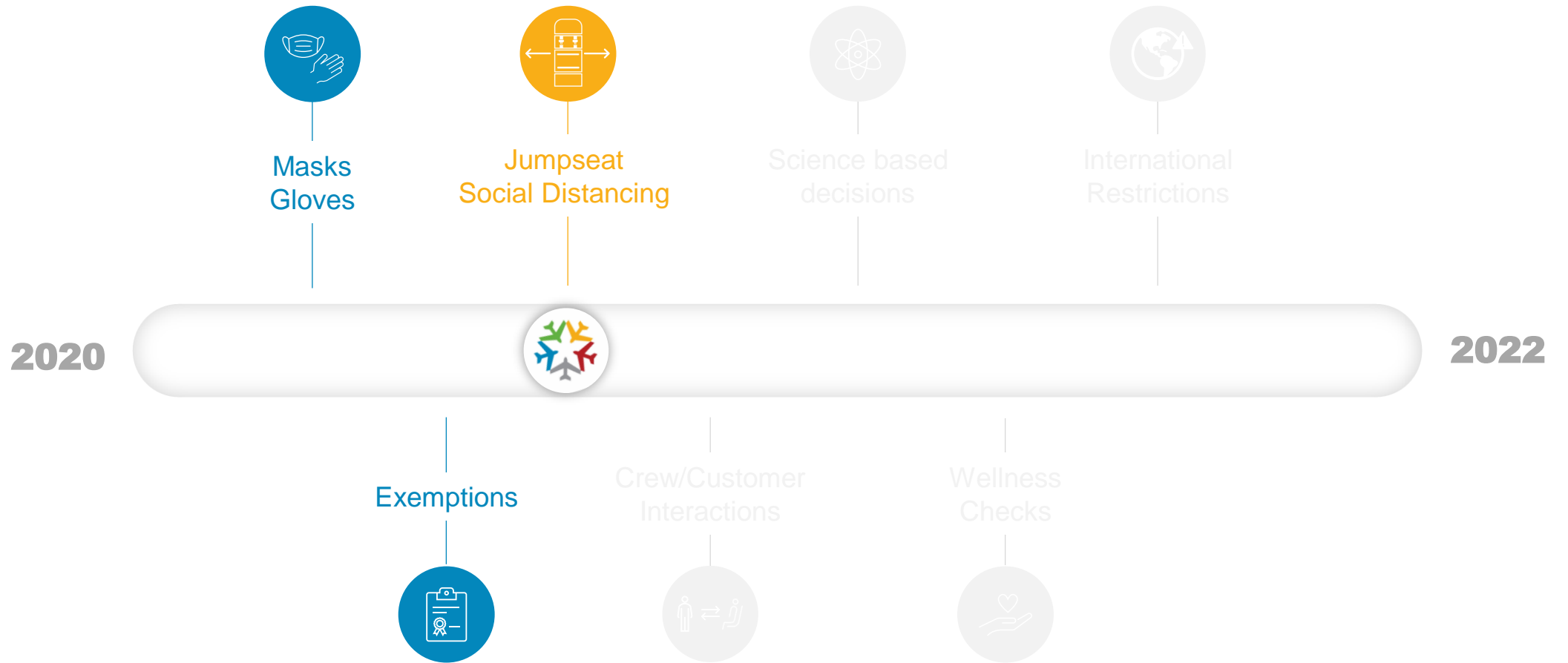

Timeline

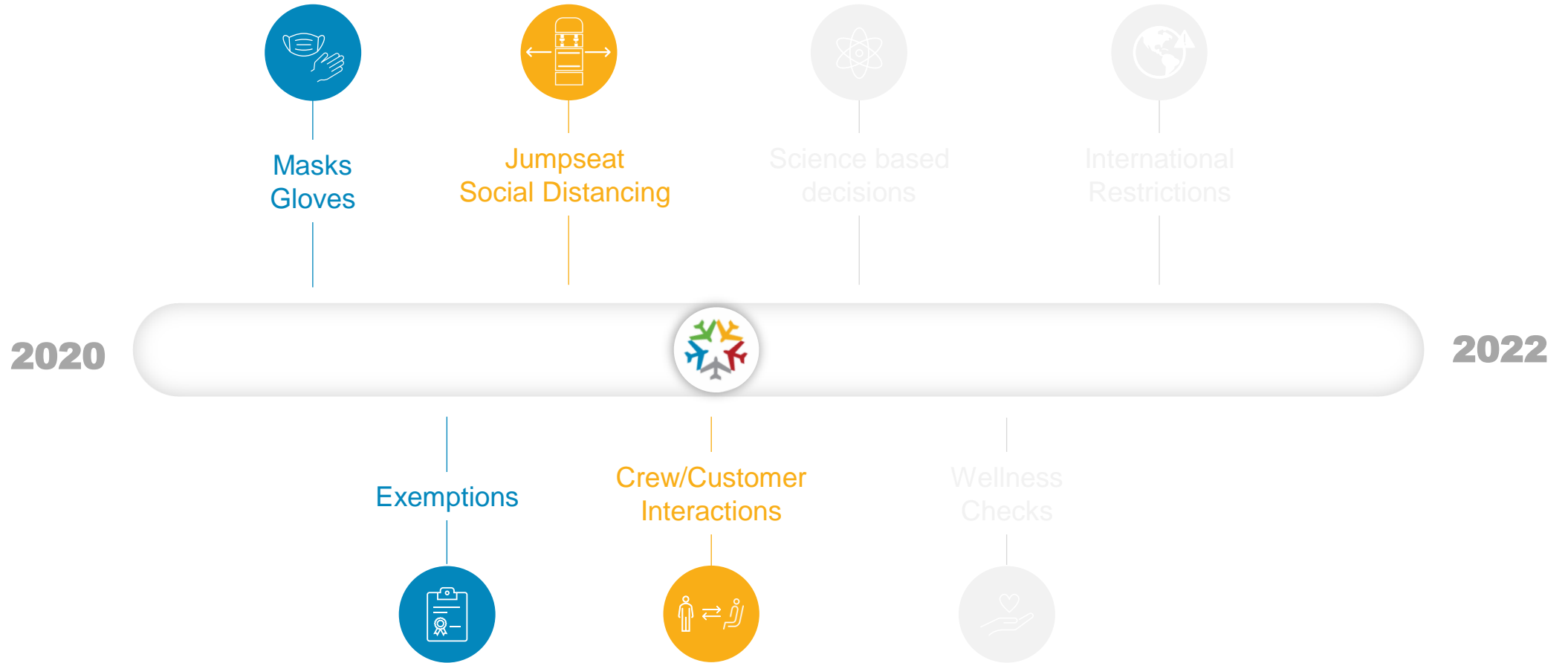

Timeline



Timeline

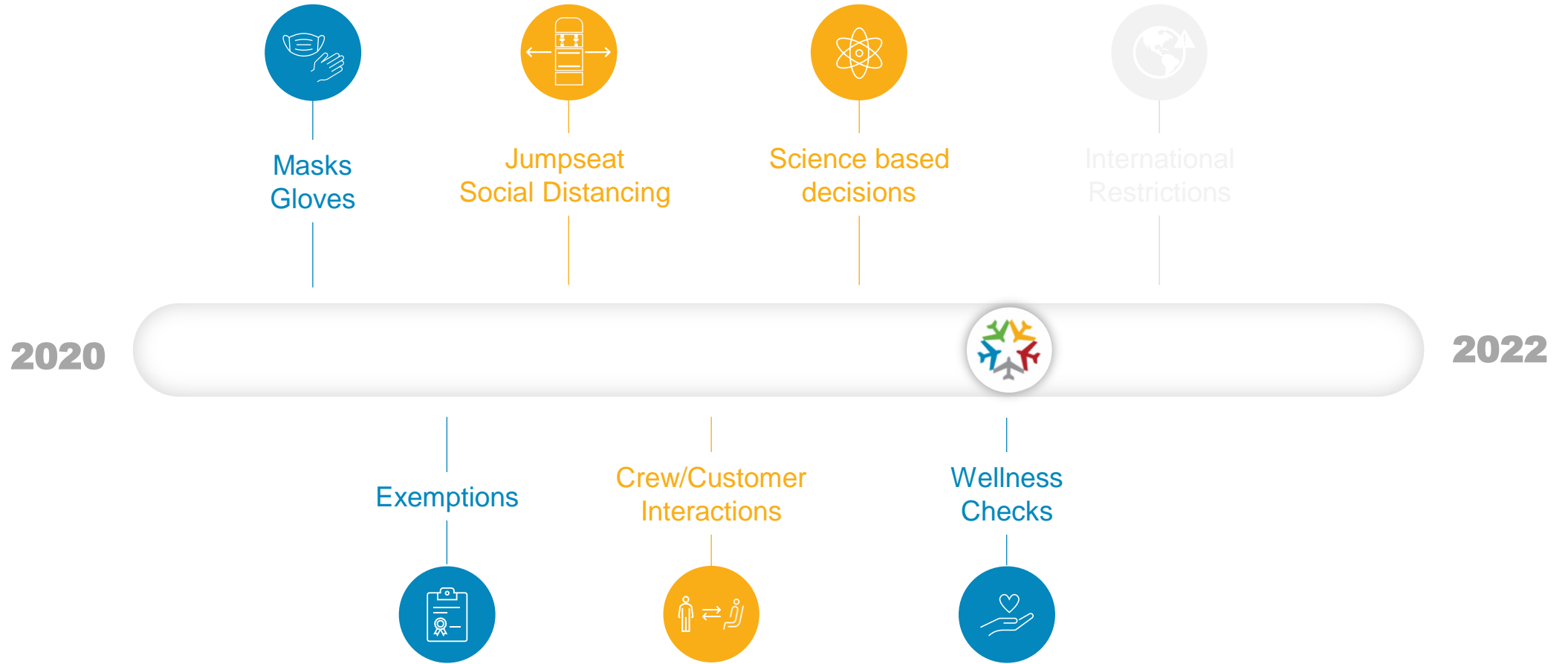

Timeline

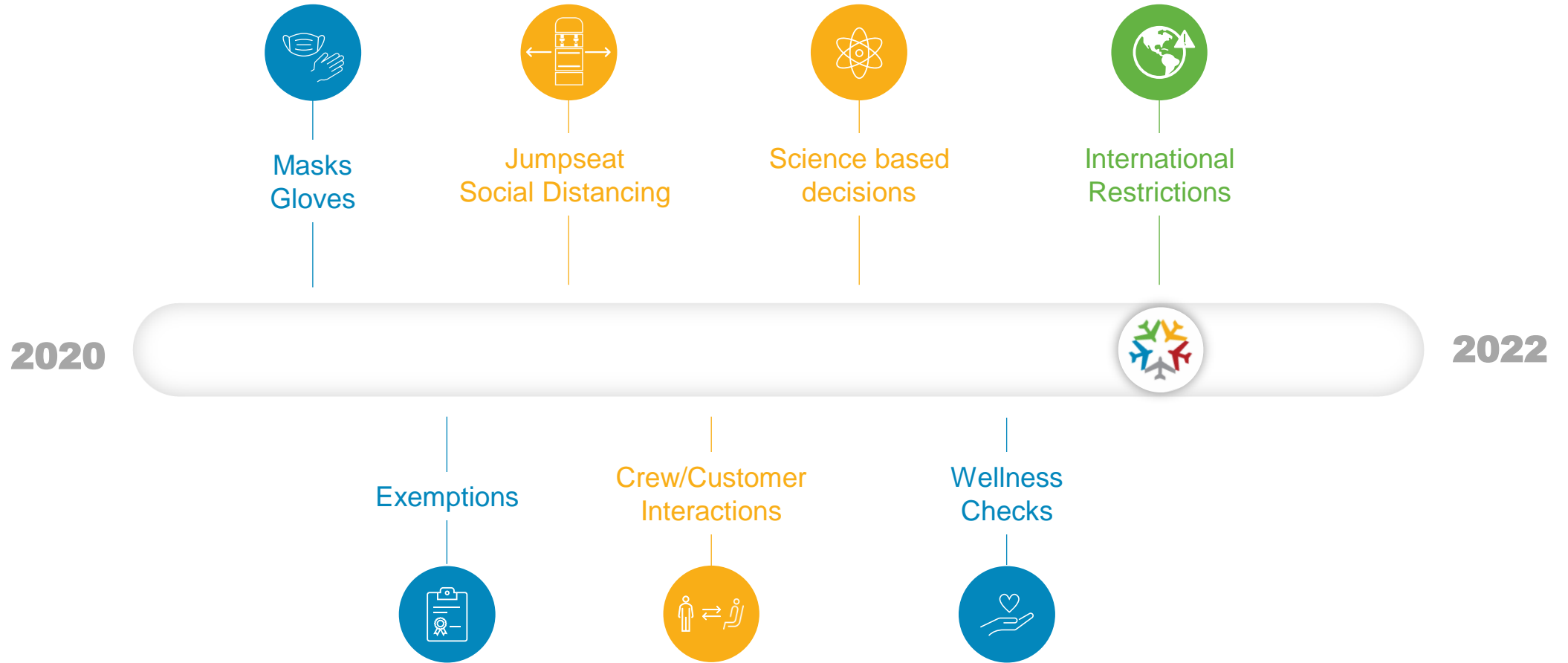

Timeline

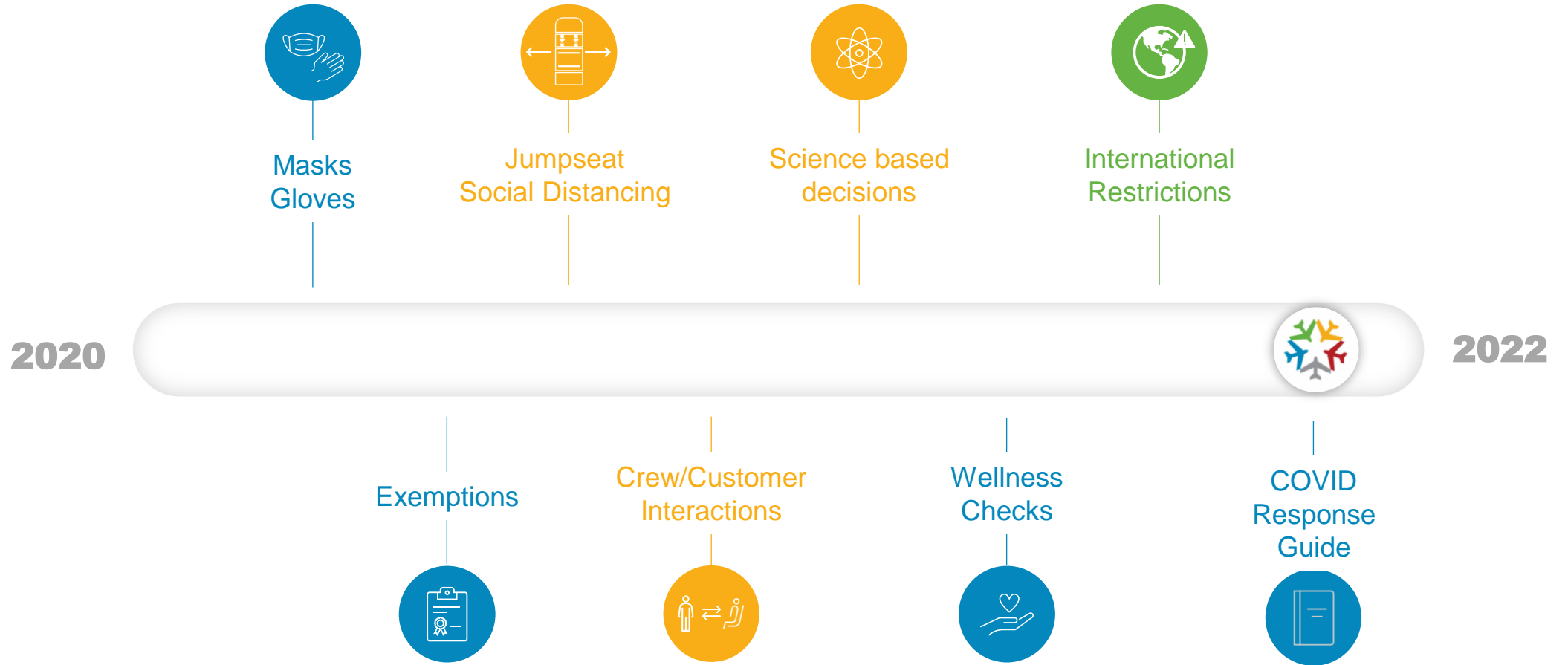



Airlines for America[®]

We Connect the World

IATA Cabin Ops Safety Task Force

Panel discussion





WESTJET



DELTA



AIRPORTUGAL

A STAR ALLIANCE MEMBER



BRITISH AIRWAYS



Lufthansa



Blue Air



AIRWAYS



TURKISH AIRLINES



Emirates



QATAR AIRWAYS
القطرية



CATHAY PACIFIC



Linhas aéreas inteligentes



australia



COSTF member responsibilities

- Review and update IOSA CAB ISARPs annually.
- Produce content for and support the COSC event.
- Review and update Cabin Operations Safety Best Practices Guide.
- Stimulate and support discussions in IATA Safety Connect.
- Review Accidents and identify potential recommendations to improve Safety.
- Identify emerging risks and conduct Cabin Safety Risk Assessments.
- Provide input to and support IATA's Cabin Safety activities.



- **Anabel Brough**, Safety Manager (Cabin), Emirates Airline (**COSTF Chair**)
- **Carlos Dias**, Cabin Safety Officer, TAP Portugal (**COSTF Vice Chair**)
- **Gennaro (Rino) Anastasio**, Cabin Safety Officer, ITA
- **Warren Elias**, Senior Manager Cabin Safety and SEP Training, Qatar Airways
- **Matthew Whipp**, Manager Cabin Safety, British Airways
- **Edwin Fernandez**, Manager Inflight Service, Cabin Safety, Analysis & Technology,
Delta Air Lines
- **Renata Garcia Borges**, Quality Cabin & Service Standards Specialist, Gol Linhas
Aereas
- **Julia Arnds**, Flight Safety Cabin Specialist, Lufthansa



IATA

CABIN OPS

SAFETY

CONFERENCE



A STAR ALLIANCE MEMBER 

Please remain seated
until we reach the gate..

Photograph competition



Prizes



Thank you for your support



Our host airline

TAP AIRPORTUGAL

A STAR ALLIANCE MEMBER



Thank you for your support

- Speakers
- Table Hosts
- Facilitators
- A4A
- Cabin Ops Safety Task Force
- And above all....

YOU!



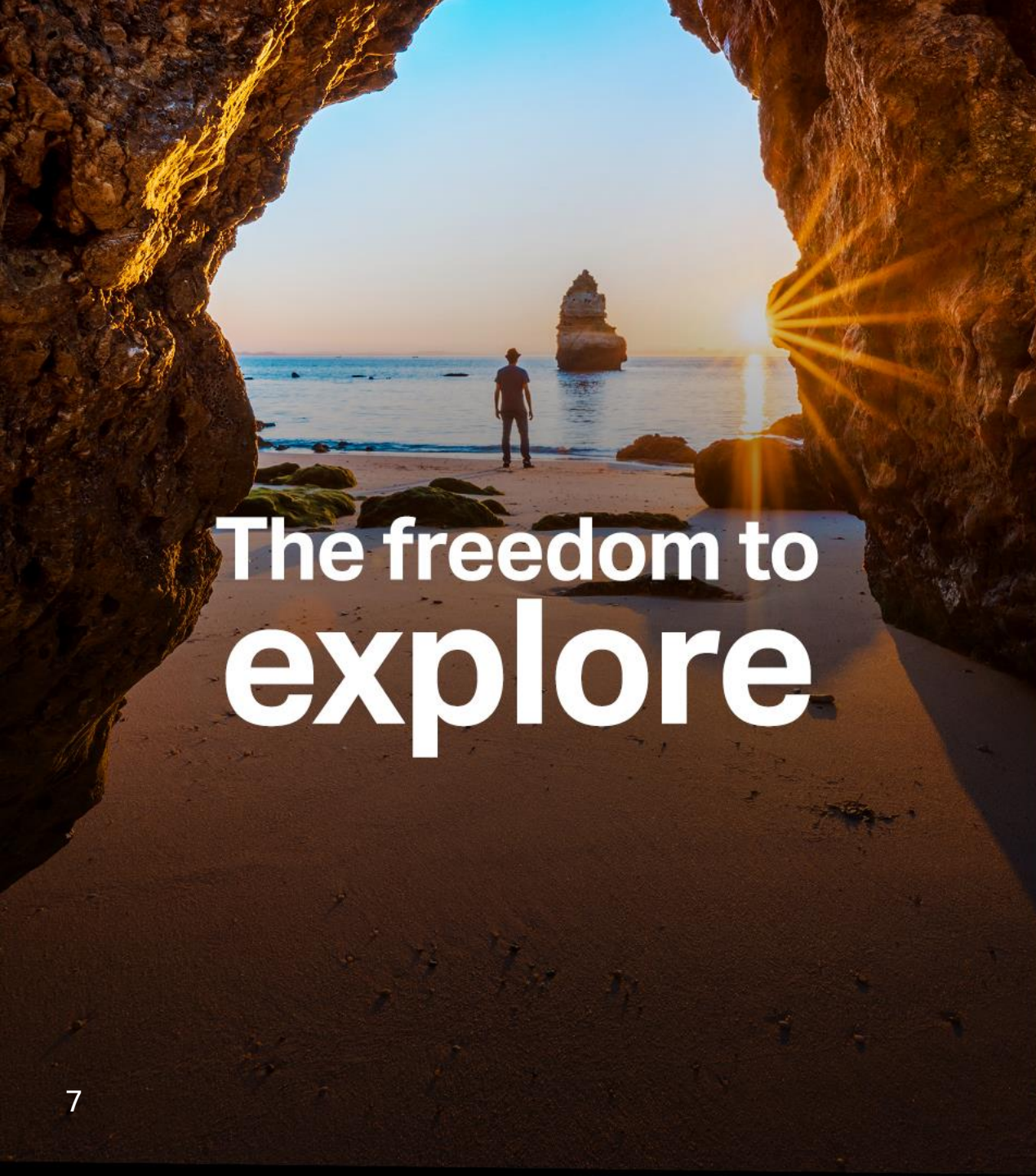

The freedom to
explore



The freedom to
learn

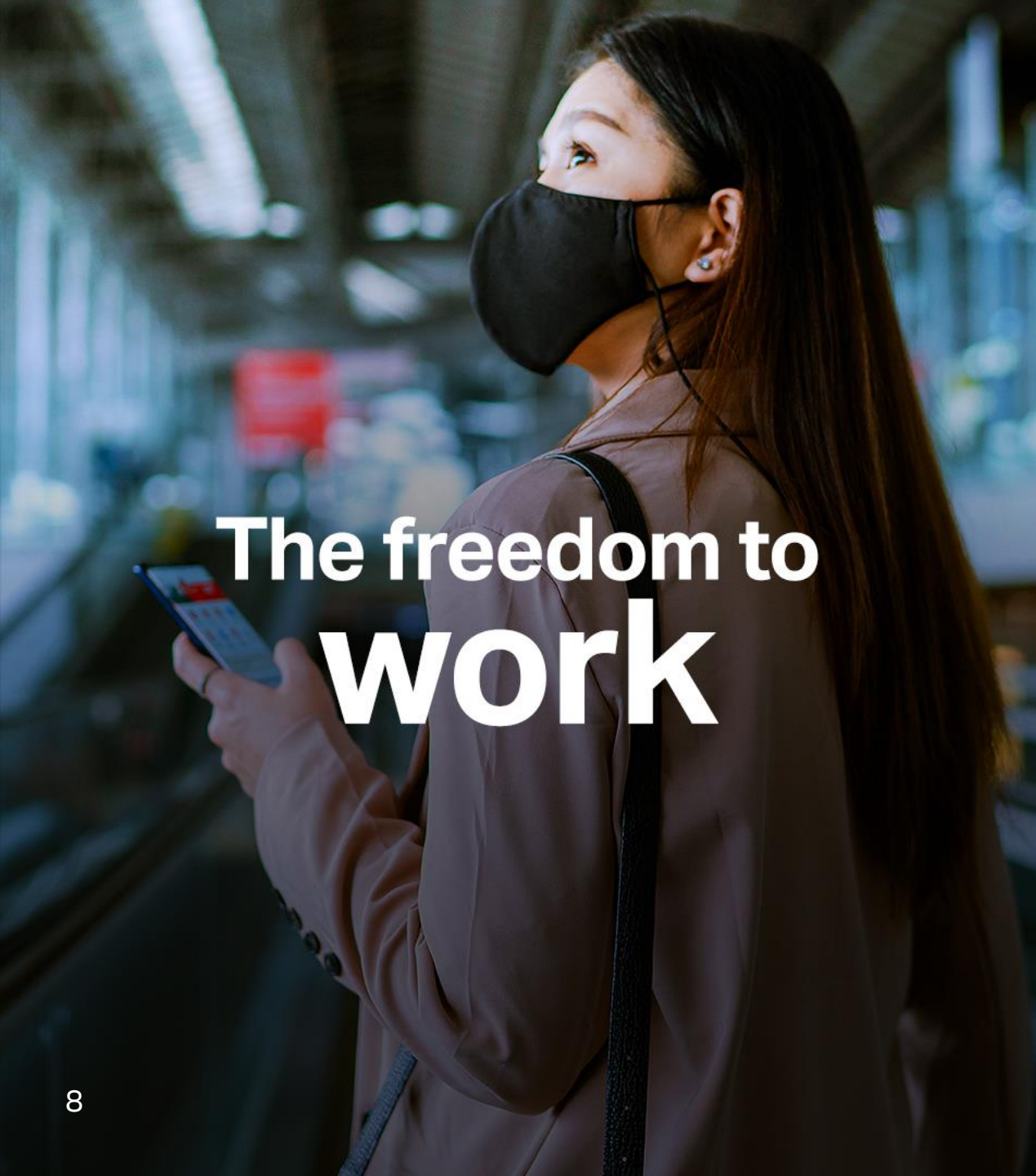

The freedom to
work



The freedom to
connect